

**WTR SERIES
PUSH-IN
FITTINGS**

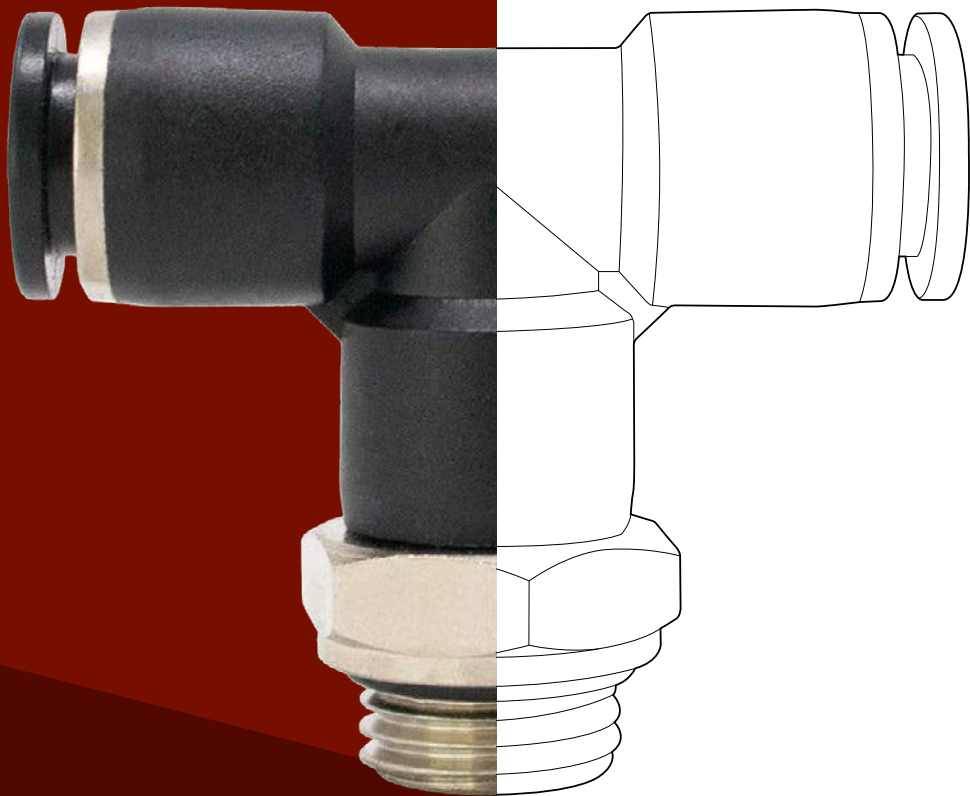

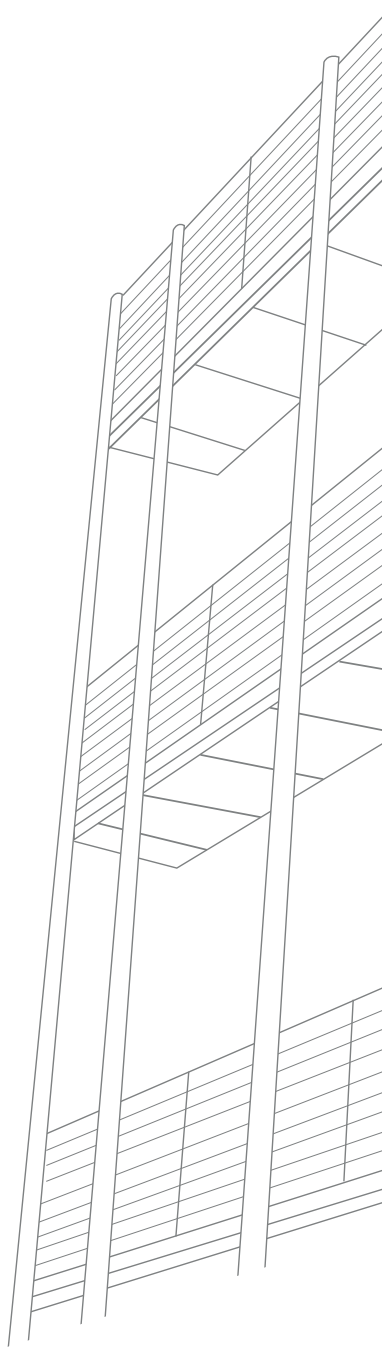



 **TierreGroup**[®]
INDUSTRIAL AUTOMATION
HYGIENIC&FOOD FOOD&BEVERAGE

 **TierreFittings**[®]

 **F-Line**[®].PRO

 **NET.Fit**[®]

 **INOX.Fit**[®]



WTR SERIES PUSH-IN FITTINGS

PLUS

COMPLETE RANGE, thanks to a 20 years experience in the market

HIGHEST LEVEL OF PERFORMANCES
working pressure up to 16 bar, increased of working temperature

PLASTIC STEM SYSTEM to allow the connection with different kind of fittings

**MADE BY TOP QUALITY
TECNOPOLYMERS** to guarantee long-lasting components

100% LEAK-PROOF TESTED

SILICON FREE MATERIALS

IN COMPLIANCE WITH ISO 14743

SUITABLE FOR VACUUM APPLICATIONS

STATIC GRIPPING SYSTEM in order to stop all the movements of the tube when inserted, granting a leak-proof connection

Every fitting is **STUDIED TO GUARANTEE THE MAXIMUM POSSIBLE FLOW RATE** accordingly to the diameter of the tube and to the thread





p. 10 / **WTRC-R**



p. 10 / **WTRC-G**



p. 11 / **WTRC-N**



p. 11 / **WTROC-R**



p. 12 / **WTROC-G**



p. 12 / **WTROC-N**



p. 13 / **WTRCF-G**



p. 13 / **WTRCF-N**



p. 14 / **WTRMF-G**



p. 14 / **WTRMF-N**



p. 15 / **WTRMM**



p. 15 / **WTRMM-N**



p. 15 / **WTRSL-R**



p. 16 / **WTRSL-G**



p. 16 / **WTRL-R**



p. 17 / **WTRL-G**



p. 18 / **WTRL-N**



p. 18 / **WTRLL-R**



p. 19 / **WTRLL-G**



p. 19 / **WTRLL-N**



p. 20 / **WTRLH-R**



p. 20 / **WTRLH-G**



p. 21 / **WTRLH-N**



p. 21 / **WTRLF-G**



p.22 / **WTRLF-N**



p. 22 / **WTRLM**



p. 22 / **WTRH-R**



p. 23 / **WTRH-G**



p. 23 / **WTRH-N**



p. 24 / **WTRHF-R**



p. 24 / **WTRHF-G**



p. 25 / **WTRHF-N**



p. 25 / **WTRT-R**



p. 26 / **WTRT-G**



p. 27 / **WTRT-N**



p. 27 / **WTRST-R**



p. 28 / **WTRST-G**



p. 28 / **WTRST-N**



p. 29 / **WTRWT-R**



p. 29 / **WTRWT-G**



p. 30 / **WTRWT-N**



p. 30 / **WTRKD-R**



p. 30 / **WTRKD-G**



p. 31 / **WTRKD-N**



p. 31 / **WTRUC**



p. 31 / **WTRUC-N**



p. 32 / **WTRG**



p. 32 / **WTRG-N**



p. 32 / **WTRUL**



p. 33 / **WTRUL-N**



p. 33 / **WTRUT**



p. 33 / **WTRUT-N**



p. 33 / **WTRGT**



p. 34 / **WTRGT-N**





p. 34 / **WTRY**



p. 34 / **WTRY-N**



p. 34 / **WTRW**



p. 35 / **WTRW-N**



p. 35 / **WTRZA**



p. 35 / **WTRZA-N**



p. 35 / **WTRK**



p. 36 / **WTRK-N**



p. 36 / **WTRKG**



p. 36 / **WTRKG-N**



p. 36 / **WTRGJ**



p. 37 / **WTRGJ-N**



p. 37 / **WTRLJ**



p. 37 / **WTRLJ-N**



p. 37 / **WTRLGJ**



p. 38 / **WTRLGJ-N**



p. 38 / **WTRYJ**



p. 38 / **WTRYJ-N**



p. 38 / **WTRWJ**



p. 39 / **WTRWJ-N**



p. 39 / **WTRKJ**



p. 39 / **WTRKJ-N**



p. 39 / **WTRPF**



p. 40 / **WTRIJ**



p. 40 / **WTRIJ-N**



p. 40 / **WTRIG**



p. 40 / **WTRIG-N**



p. 41 / **WTRP**



p. 41 / **WTRP-N**



p. 41 / **WTRUC-PRD**

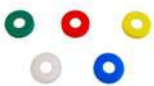

p. 41 / **WTRCV**



p. 41 / **TR**



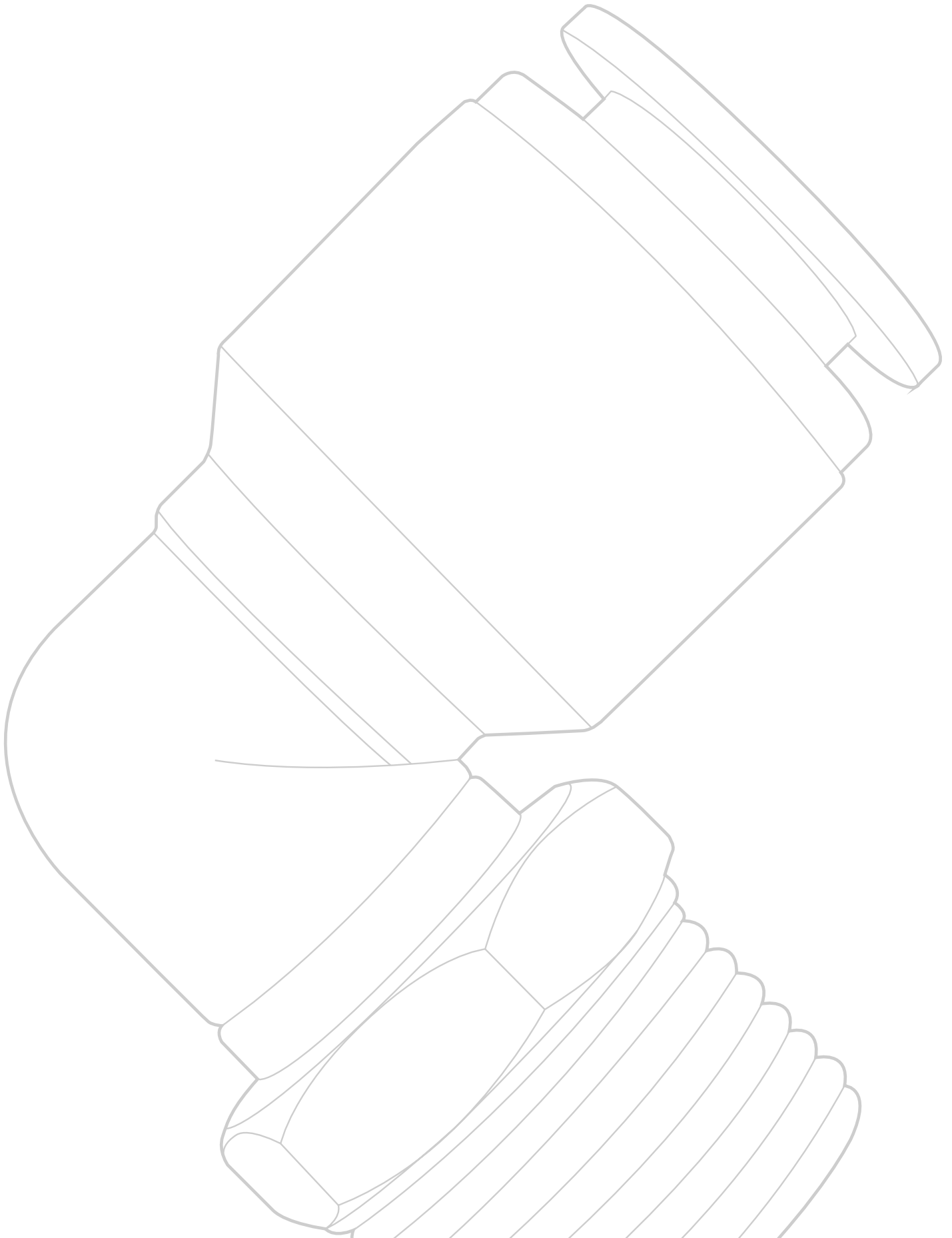

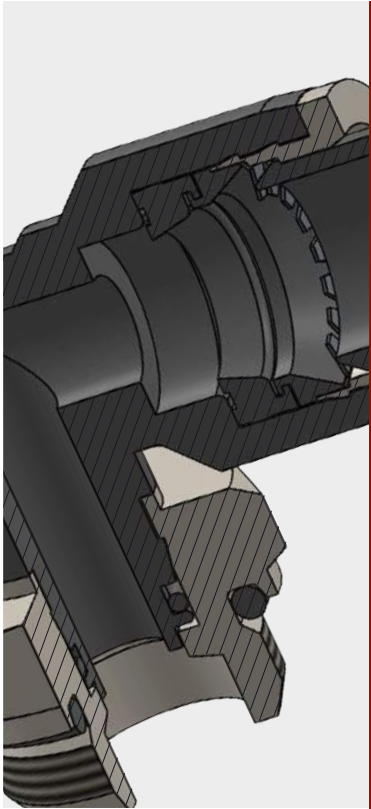

-20°C ÷ 80°C



Working pressure:

16 Bar

Negative pressure:

- 750 mmHg (- 0,999 Bar)



Compressed air & vacuum



- Taper gas BSPT ISO 7 from R1/8" to R1/2" with teflon
- Parallel gas BSPP ISO 228 from G1/8" to G1/2"
- Metric ISO 262 M5, M6, M7
- NPT from N1/8" to N1/2"
- UNF 10-32



Polyamide PA,
Polyurethane PU,
Polyethylene PE

Body: nickel plated brass and high performance BPT

Release sleeve: acetal resin POM



Cartridge: nickel plated zinc

Lock claw: stainless steel AISI 301

Back ring: POM

O-ring: NBR silicon free

V-Seal: NBR silicon free



Products in compliance with the directive 1907/2006



RoHS2

Products in compliance with the directive 2011/65/UE

SILICON FREE

CONSTRUCTION DETAILS

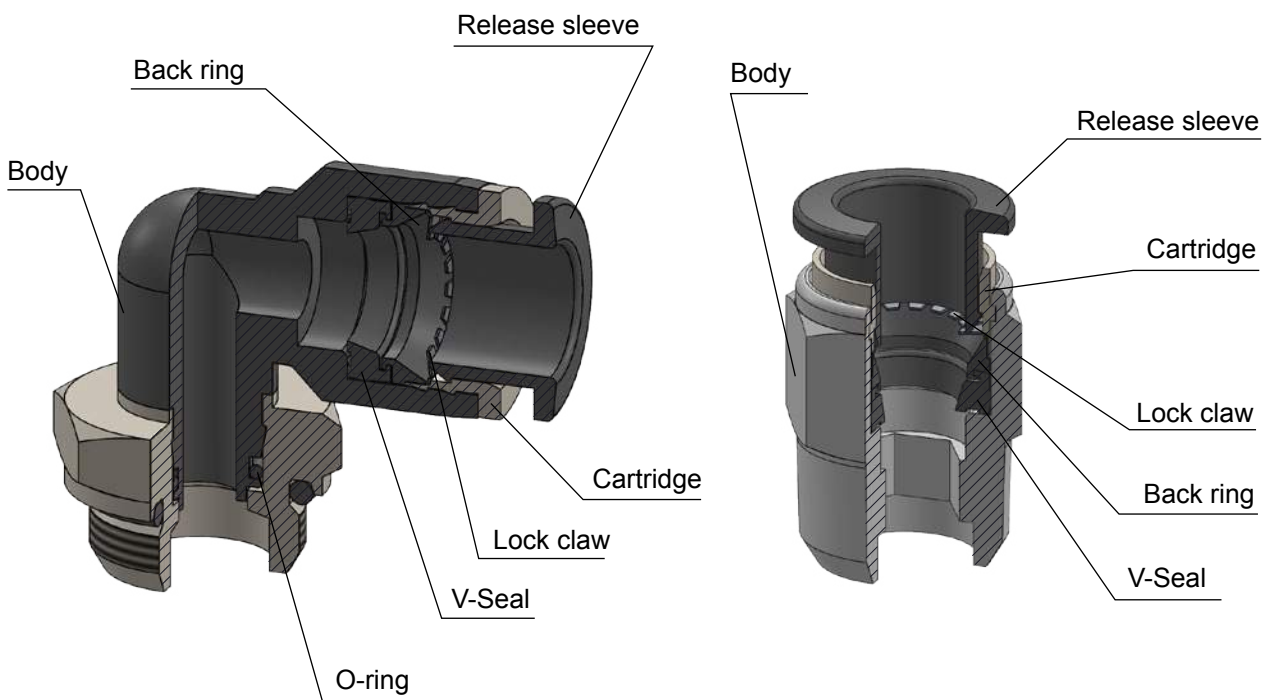

INSERTION OF THE TUBE INTO THE FITTING

- Make sure the tube is fully inserted into the fitting.
- To insert the tube into the fitting cut the tube off square (90°), insert tube up to the fitting end stop, and pull back gently to make sure it is correctly connected.
- If there is any damage or scratches on the tube surface the tube is an oval shape, air leakage and tube release may occur. Check the tube condition carefully.
- The OD of polyurethane tube expands when pressure is applied. Reinsertion into the fitting may not always be possible. Check the OD of the tube and renew it the expansion is out of tolerance.

DISCONNECTION OF THE TUBE FROM THE FITTING

- Make sure the pressure in the system is zero before releasing the tube from the fitting.
- To release the tube, press the release sleeve towards the fitting with one hand and pull the tube away from the fitting with the other hand.
- Always remove the section of tube previously inserted into the fitting before reinserting the tube by cutting back the tube. Always use the correct tube cutter in order to cut the tube square and free of damage.

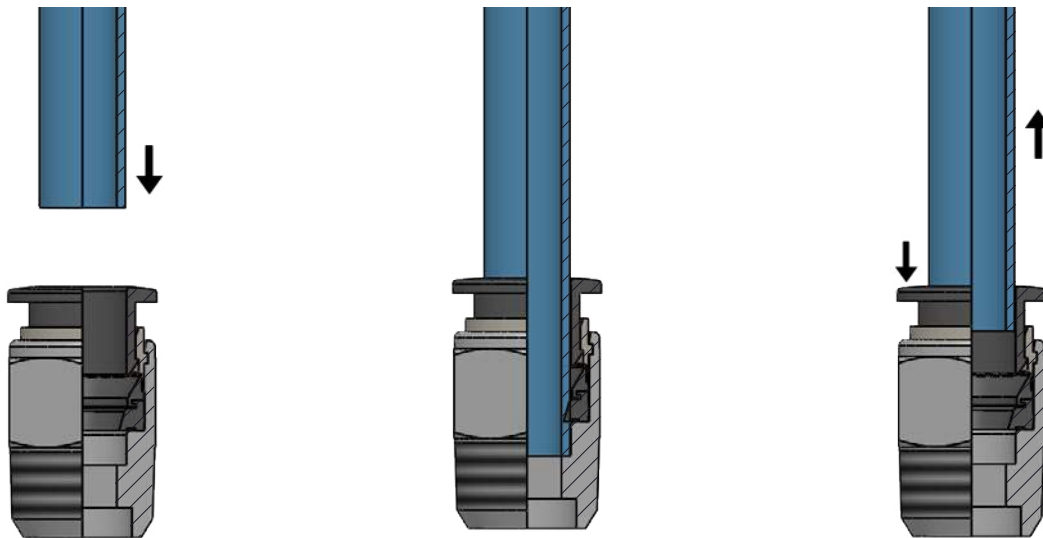

TOLERANCE - METRIC TUBE

Ø TUBE (mm)	4	6	8	10	12	14	16
TOLERANCE (mm)	± 0,1	± 0,1	± 0,1	± 0,15	± 0,15	± 0,15	± 0,15

TOLERANCE - INCH TUBE

Ø TUBE	5/32	3/16	1/4	5/16	3/8	1/2
TOLERANCE (inch)	±0,003	±0,003	±0,003	±0,003	±0,005	±0,005



WTRC-R

Male connector with internal hexagon BSPT thread nickel plated

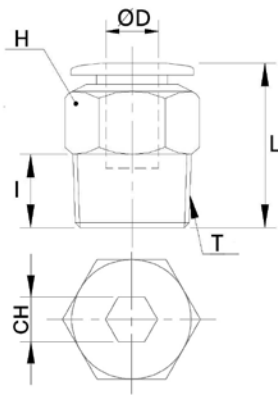

CODE	ØD	T	I	L	CH	H	GR.
WTRC04R01	4	R 1/8"	7,0	19,3	3,0	10	6,2
WTRC04R02		R 1/4"	9,5	17,9	3,0	14	9,8
WTRC06R01	6	R 1/8"	7,0	20,4	4,0	12	6,9
WTRC06R02		R 1/4"	9,5	22,7	4,0	14	13,3
WTRC06R03		R 3/8"	10,5	20,7	4,0	17	19,9
WTRC06R04		R 1/2"	13,5	24,7	4,0	21	39,8
WTRC08R01	8	R 1/8"	7,0	25,4	5,0	14	10,0
WTRC08R02		R 1/4"	9,5	24,9	6,0	14	11,9
WTRC08R03		R 3/8"	10,5	21,9	6,0	17	17,5
WTRC08R04		R 1/2"	13,5	25,9	6,0	21	37,6
WTRC10R01	10	R 1/8"	7,0	27,7	5,0	17	16,4
WTRC10R02		R 1/4"	9,5	29,5	6,0	17	18,6
WTRC10R03		R 3/8"	10,5	27,0	8,0	17	20,7
WTRC10R04		R 1/2"	13,5	25,3	8,0	21	34,6
WTRC12R02	12	R 1/8"	9,5	32,9	6,0	20	24,5
WTRC12R03		R 1/4"	10,5	29,9	8,0	20	25,3
WTRC12R04		R 1/2"	13,5	32,9	8,0	21	41,0
WTRC16R03	16	R 1/8"	10,5	37,6	8,0	24	42,0
WTRC16R04		R 1/4"	13,5	35,6	10,0	24	42,1

WTRC-G

Male connector with internal hexagon BSPP & metric thread nickel plated

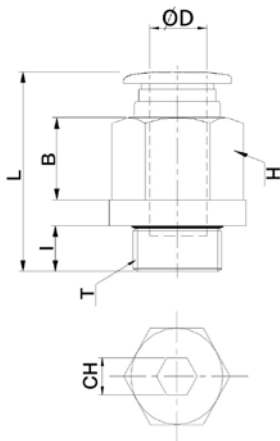

CODE	ØD	T	I	L	B	CH	H	GR.
WTR04M5	4	M5x0,8	3,8	20,1	10,5	2,0	10	5,7
WTR04M6		M6x1	4,5	20,8	10,5	2,5	10	6,1
WTR04M7		M7x1	4,5	20,8	10,5	3,0	10	6,9
WTR04G01		G 1/8"	5,0	19,3	7,4	3,0	10	7,4
WTR04G02		G 1/4"	5,8	16,6	3,9	3,0	10	9,4
WTR06M5	6	M5x0,8	3,8	21,2	10,5	2,0	12	7,4
WTR06M6		M6x1	4,5	21,7	10,5	2,5	12	7,0
WTR06M7		M7x1	4,5	21,9	10,5	3,0	12	7,2
WTR06G01		G 1/8"	5,0	19,9	6,7	4,0	12	7,5
WTR06G02		G 1/4"	5,8	20,4	6,4	4,0	12	10,8
WTR06G03		G 3/8"	6,8	20,0	4,5	4,0	12	17,0
WTR06G04		G 1/2"	8,0	21,7	4,5	4,0	12	27,5
WTR08G01	8	G 1/8"	5,0	24,4	11,1	5,0	14	11,7
WTR08G02		G 1/4"	5,8	22,2	7,0	6,0	14	11,1
WTR08G03		G 3/8"	6,8	21,2	4,5	6,0	14	15,7
WTR08G04		G 1/2"	8,0	22,9	4,5	6,0	14	27,0
WTR10G01	10	G 1/8"	5,0	26,3	11,0	5,0	17	15,9
WTR10G02		G 1/4"	5,8	27,5	13,9	6,0	17	20,4
WTR10G03		G 3/8"	6,8	25,0	8,9	8,0	17	20,6
WTR10G04		G 1/2"	8,0	22,7	4,9	8,0	17	28,5
WTR12G02	12	G 1/4"	5,8	31,2	12,0	6,0	20	26,3
WTR12G03		G 3/8"	6,8	28,2	11,0	8,0	20	24,3
WTR12G04		G 1/2"	8,0	28,9	9,5	8,0	20	33,3
WTR14G03	14	G 3/8"	6,8	31,8	13,0	8,0	21	30,0
WTR14G04		G 1/2"	8,0	29,5	10,0	10,0	24	20,0
WTR16G03	16	G 3/8"	6,8	34,9	14,5	8,0	24	42,0
WTR16G04		G 1/2"	8,0	36,1	18,0	10,0	24	50,7



WTRC-N

Male connector with internal hexagon NPT & UNF thread nickel plated

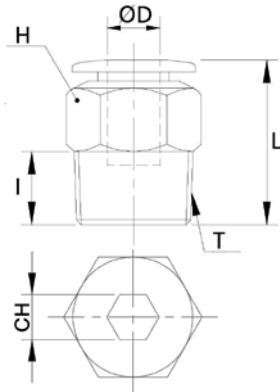

CODE	ØD	T	I	L	CH	H	LB
WTRC532UF1032	5/32	UNF 10-32	0,149	0,799	0,093	0,437	0,012
WTRC532N01		N 1/8"	0,295	0,779	0,093	0,437	0,013
WTRC532N02		N 1/4"	0,413	0,744	0,093	0,562	0,021
WTRC316UF1032	3/16	UNF 10-32	0,149	0,822	0,093	0,437	0,014
WTRC316N01		N 1/8"	0,295	0,811	0,156	0,437	0,027
WTRC316N02		N 1/4"	0,413	0,933	0,156	0,562	0,041
WTRC316N03		N 3/8"	0,433	0,834	0,156	0,578	0,083
WTRC1-4UF1032	1/4	UNF 10-32	0,149	0,834	0,093	0,5	0,015
WTRC1-4N01		N 1/8"	0,295	0,822	0,156	0,5	0,029
WTRC1-4N02		N 1/4"	0,413	0,933	0,156	0,562	0,043
WTRC1-4N03		N 3/8"	0,433	0,834	0,156	0,685	0,087
WTRC516N01	5/16	N 1/8"	0,295	1,019	0,187	0,562	0,022
WTRC516N02		N 1/4"	0,143	1,019	0,218	0,562	0,026
WTRC516N03		N 3/8"	0,433	0,881	0,218	0,685	0,038
WTRC38N01	3/8	N 1/8"	0,295	1,110	0,187	0,685	0,036
WTRC38N02		N 1/4"	0,143	1,200	0,218	0,685	0,041
WTRC38N03		N 3/8"	0,433	1,011	0,312	0,685	0,045
WTRC38N04		N 1/2"	0,551	1,015	0,312	0,874	0,076
WTRC1-2N02	1/2	N 1/4"	0,413	1,334	0,250	0,874	0,054
WTRC1-2N03		N 3/8"	0,433	1,196	0,312	0,874	0,055
WTRC1-2N04		N 1/2"	0,551	1,314	0,312	0,874	0,090

WTROC-R

Male connector with internal hexagon BSPT thread nickel plated

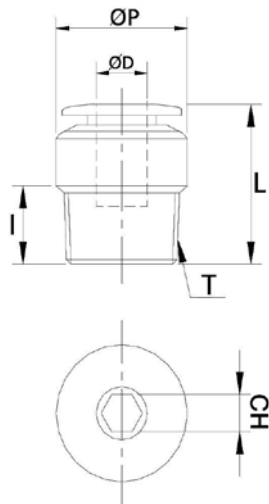

CODE	ØD	T	I	L	ØP	CH	H	GR.
WTROC04R01	4	R 1/8"	7,0	19,3	10	3,0	3,0	5,6
WTROC04R02		R 1/4"	9,5	17,9	14	3,0	3,0	11,2
WTROC06R01	6	R 1/8"	7,0	20,4	12	4,0	4,0	6,3
WTROC06R02		R 1/4"	9,5	22,7	14	4,0	4,0	12,5
WTROC06R03		R 3/8"	10,5	20,7	17	4,0	4,0	19,0
WTROC08R01	8	R 1/8"	7,0	25,4	14	5,0	5,0	10,2
WTROC08R02		R 1/4"	9,5	24,9	14	6,0	6,0	13,1
WTROC08R03		R 3/8"	10,5	21,9	17	6,0	6,0	17,3
WTROC08R04		R 1/2"	13,5	25,9	21	6,0	6,0	37,9
WTROC10R01	10	R 1/8"	7,0	27,7	17	5,0	5,0	20,8
WTROC10R02		R 1/4"	9,5	29,5	17	6,0	6,0	22,5
WTROC10R03		R 3/8"	10,5	27,0	17	8,0	8,0	22,6
WTROC10R04		R 1/2"	13,5	25,3	21	8,0	8,0	34,0
WTROC12R02	12	R 1/4"	9,5	32,9	20	6,0	6,0	21,5
WTROC12R03		R 3/8"	10,5	29,9	20	8,0	8,0	22,2
WTROC12R04		R 1/2"	13,5	32,9	21	8,0	8,0	37,3



WTROC-G

Male connector with internal hexagon metric thread nickel plated

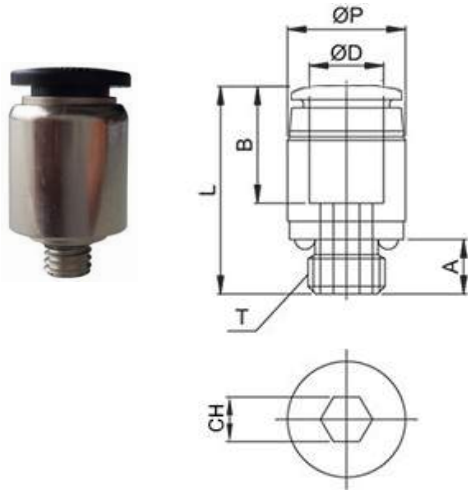

CODE	ØD	T	I	L	ØP	CH	GR.
WTROC04M5	4	M5x0,8	3,8	20,1	10	2,0	5,2
WTROC04M6		M6x1	4,5	20,8	10	2,0	5,6
WTROC06M5	6	M5x0,8	3,8	21,0	12	2,0	6,8
WTROC06M6		M6x1	4,5	21,7	12	2,0	7,2

WTROC-N

Male connector with internal hexagon NPT & UNF thread nickel plated

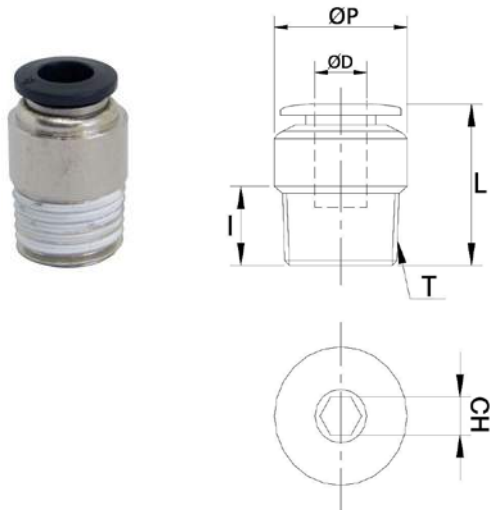

CODE	ØD	T	I	L	CH	H	LB
WTROC532UF1032	5/32	UNF 10-32	0,149	0,799	0,093	0,393	0,011
WTROC532N01		N 1/8"	0,295	0,799	0,093	0,393	0,012
WTROC1-4UF1032	1/4	UNF 10-32	0,149	0,834	0,093	0,472	0,013
WTROC1-4N01		N 1/8"	0,295	0,822	0,156	0,472	0,014
WTROC1-4N02		N 1/4"	0,413	0,933	0,156	0,551	0,027
WTROC516N01	5/16	N 1/8"	0,295	1,019	0,187	0,551	0,022
WTROC516N02		N 1/4"	0,413	1,019	0,218	0,551	0,028
WTROC516N03		N 3/8"	0,433	0,881	0,218	0,669	0,038
WTROC38N02	3/8	N 1/4"	0,413	1,200	0,218	0,669	0,049
WTROC38N03		N 3/8"	0,433	1,011	0,312	0,669	0,049
WTROC38N04		N 1/2"	0,551	1,015	0,312	0,826	0,074
WTROC1-2N02	1/2	N 1/4"	0,413	1,334	0,250	0,826	0,047
WTROC1-2N03		N 3/8"	0,433	1,196	0,312	0,826	0,048
WTROC1-2N04		N 1/2"	0,551	1,314	0,313	0,826	0,082



WTRCF-G

Female connector BSPP thread nickel plated

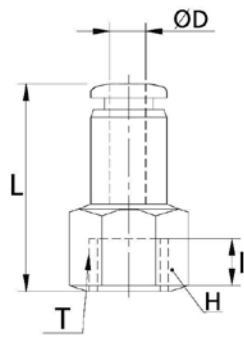

CODE	ØD	T	I	L	H	GR.
WTRCF04G01	4	G 1/8"	7,0	22,3	14	12,5
WTRCF04G02		G 1/4"	9,0	25,3	17	18,0
WTRCF06G01	6	G 1/8"	7,0	24,4	14	15,0
WTRCF06G02		G 1/4"	9,0	26,4	17	19,3
WTRCF06G03		G 3/8"	10,0	27,4	19	26,3
WTRCF08G01	8	G 1/8"	7,0	25,9	14	15,8
WTRCF08G02		G 1/4"	9,0	27,9	17	19,4
WTRCF08G03		G 3/8"	10,0	28,9	19	18,4
WTRCF08G04		G 1/2"	12,0	30,9	24	32,8
WTRCF10G01	10	G 1/8"	7,0	27,7	17	28,5
WTRCF10G02		G 1/4"	9,0	29,7	17	27,0
WTRCF10G03		G 3/8"	10,0	30,7	19	24,6
WTRCF10G04		G 1/2"	12,0	32,7	24	38,5
WTRCF12G02	12	G 1/4"	9,0	32,9	20	44,2
WTRCF12G03		G 3/8"	10,0	33,9	20	35,9
WTRCF12G04		G 1/2"	12,0	35,9	24	34,2

WTRCF-N

Female connector NPT thread nickel plated

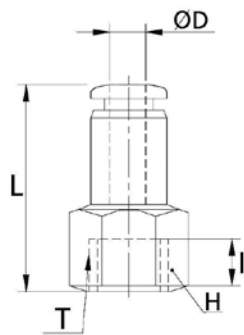

CODE	ØD	T	I	L	H	LB
WTRCF532N01	5/32	N 1/8"	0,295	0,937	0,562	0,027
WTRCF532N02		N 1/4"	0,413	1,055	0,685	0,039
WTRCF316N01	3/16	N 1/8"	0,295	0,960	0,562	0,031
WTRCF316N02		N 1/4"	0,413	1,078	0,685	0,040
WTRCF1-4N01	1/4	N 1/8"	0,295	0,980	0,562	0,033
WTRCF1-4N02		N 1/4"	0,413	1,098	0,685	0,042
WTRCF516N01	5/16	N 1/8"	0,295	1,039	0,562	0,034
WTRCF516N02		N 1/4"	0,413	1,157	0,685	0,042
WTRCF516N03		N 3/8"	0,433	1,177	0,874	0,040
WTRCF38N02	3/8	N 1/4"	0,413	1,228	0,685	0,059
WTRCF38N03		N 3/8"	0,433	1,248	0,874	0,054
WTRCF1-2N02	1/2	N 1/4"	0,413	1,354	0,874	0,097
WTRCF1-2N03		N 3/8"	0,433	1,374	0,874	0,079



WTRMF-G

Bulkhead female connector BSPP thread nickel plated

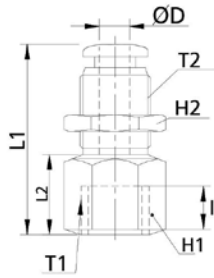

CODE	ØD	T1	T2	I	H1	H2	L1	L2	GR.
WTRMF04G01	4	G 1/8"	M12x1	7,0	14	14	23,3	9,5	15,5
WTRMF04G02		G 1/4"	M12x1	9,0	17	14	25,4	11,6	20,4
WTRMF06G01	6	G 1/8"	M14x1	7,0	17	17	24,2	7,0	26,3
WTRMF06G02		G 1/4"	M14x1	9,0	17	17	29,2	12,0	26,5
WTRMF06G03		G 3/8"	M14x1	10,0	19	17	30,2	13,0	35,1
WTRMF08G01	8	G 1/8"	M16x1	7,0	19	19	27,4	5,0	32,0
WTRMF08G02		G 1/4"	M16x1	9,0	19	19	34,4	12,0	42,4
WTRMF08G03		G 3/8"	M16x1	10,0	19	19	34,4	13,0	42,4
WTRMF08G04		G 1/2"	M16x1	12,0	24	19	36,4	15,0	47,7
WTRMF10G01	10	G 1/8"	M20x1	7,0	21	24	28,4	7,7	52,8
WTRMF10G02		G 1/4"	M20x1	9,0	21	24	30,4	9,7	53,5
WTRMF10G03		G 3/8"	M20x1	10,0	21	24	33,7	13,0	53,8
WTRMF10G04		G 1/2"	M20x1	12,0	24	24	35,7	15,0	58,8
WTRMF12G02	12	G 1/4"	M22x1	9,0	24	27	33,5	9,1	68,2
WTRMF12G03		G 3/8"	M22x1	10,0	24	27	34,4	10,0	62,7
WTRMF12G04		G 1/2"	M22x1	12,0	24	27	39,4	15,0	62,3

WTRMF-N

Bulkhead female connector NPT thread nickel plated

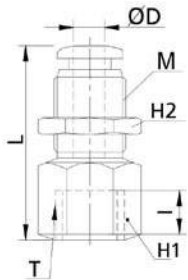

CODE	ØD	T	M	I	H1	H2	L	LB
WTRMF532N01	5/32	N 1/8"	M12X1	0,295	0,562	0,562	0,937	0,034
WTRMF316N02	3/16	N 1/4"	M14X1	0,413	0,685	0,685	1,196	0,055
WTRMF1-4N01	1/4	N 1/8"	M14X1	0,295	0,685	0,685	0,972	0,057
WTRMF1-4N02	1/4	N 1/4"	M14X1	0,413	0,685	0,685	1,196	0,058
WTRMF516N01	5/16	N 1/8"	M16X1	0,295	0,685	0,748	1,098	0,070
WTRMF516N02	5/16	N 1/4"	M16X1	0,413	0,748	0,748	1,413	0,093
WTRMF516N03	5/16	N 3/8"	M16X1	0,433	0,748	0,748	1,393	0,093
WTRMF38N02	3/8	N 1/4"	M20X1	0,413	0,874	0,874	1,255	0,117
WTRMF38N03	3/8	N 3/8"	M20X1	0,433	0,874	0,874	1,366	0,118
WTRMF1-2N03	1/2	N 3/8"	M22X1	0,433	1,0	1,0	1,393	0,138
WTRMF1-2N04	1/2	N 1/2"	M22X1	0,551	1,0	1,0	1,629	0,137



WTRMM

Bulkhead connector nickel plated

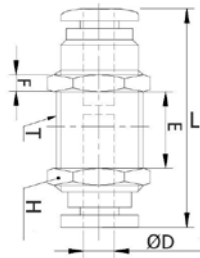

CODE	ØD	T	E	L	F	H	GR.
WTRMM0400	4	M12x1	9,7	30,1	3,5	14	15,4
WTRMM0600	6	M14x1	7,5	31,8	4,0	17	21,4
WTRMM0800	8	M16x1	6,8	35,3	4,5	19	26,8
WTRMM1000	10	M20x1	11,5	39,0	5,0	24	52,7
WTRMM1200	12	M22x1	12,8	45,3	5,0	27	59,8

WTRMM-N

Bulkhead connector nickel plated

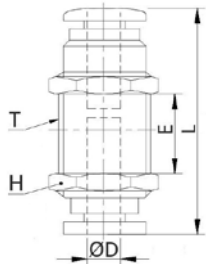

CODE	ØD	T	E	L	H	LB
WTRMM532	5/32	M12x1	0,381	1,185	0,562	0,034
WTRMM316	3/16	M14x1	0,295	1,251	0,685	0,045
WTRMM1-4	1/4	M14x1	0,295	1,251	0,685	0,047
WTRMM516	5/16	M16x1	0,267	1,389	0,748	0,059
WTRMM38	3/8	M20x1	0,350	1,433	0,874	0,116
WTRMM1-2	1/2	M22x1	0,503	1,783	1,0	0,131

WTRSL-R

Short swivel male elbow BSPT thread nickel plated

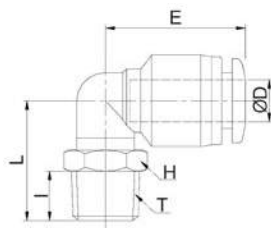

CODE	ØD	T	I	L	E	H	GR.
WTRSL04R01	4	R 1/8"	7,0	16,0	17,5	10,0	5,8
WTRSL04R02		R 1/4"	9,5	19,5	17,5	14,0	6,3
WTRSL06R01	6	R 1/8"	7,0	17,0	19,0	10,0	6,4
WTRSL06R02		R 1/4"	9,5	20,5	19,0	14,0	12,4
WTRSL06R03		R 3/8"	10,5	22,0	19,0	17,0	14,2
WTRSL06R04		R 1/2"	13,5	25,5	19,0	21,0	17,3
WTRSL08R01	8	R 1/8"	7,0	21,3	22,8	12,0	11,5
WTRSL08R02		R 1/4"	9,5	21,5	22,8	14,0	13,3
WTRSL08R03		R 3/8"	10,5	23,0	22,8	17,0	20,3
WTRSL08R04		R 1/2"	13,5	26,5	22,8	21,0	21,9
WTRSL10R01	10	R 1/8"	7,0	25,5	26,3	14,0	15,4
WTRSL10R02		R 1/4"	9,5	26,0	26,3	14,0	18,4
WTRSL10R03		R 3/8"	10,5	25,0	26,3	17,0	21,9
WTRSL10R04		R 1/2"	13,5	28,5	26,3	21,0	24,8
WTRSL12R02	12	R 1/4"	9,5	29,5	29,6	17,0	33,6
WTRSL12R03		R 3/8"	10,5	26,5	29,6	17,0	36,2
WTRSL12R04		R 1/2"	13,5	30,0	29,6	21,0	39,5



WTRSL-G

Short swivel male elbow BSPP & metric thread nickel plated



CODE	ØD	T	I	L	E	H	GR.
WTRSL04M5	4	M5x0,8	3,8	15,3	17,5	8,0	5,2
WTRSL04M7		M7x1	4,5	17,0	17,5	10,0	6,1
WTRSL04G01		G 1/8"	4,8	14,8	17,5	14,0	7,6
WTRSL04G02		G 1/4"	5,5	16,0	17,5	17,0	11,3
WTRSL06M5	6	M5x0,8	3,8	15,3	19,0	8,0	5,8
WTRSL06M7		M7x1	4,5	17,0	19,0	10,0	6,7
WTRSL06G01		G 1/8"	4,8	15,8	19,0	14,0	8,3
WTRSL06G02		G 1/4"	5,5	17,0	19,0	17,0	13,3
WTRSL06G03	6	G 3/8"	6,5	18,5	19,0	20,0	16,8
WTRSL06G04		G 1/2"	7,5	19,5	19,0	24,0	20,1
WTRSL08G01	8	G 1/8"	4,8	20,0	22,8	14,0	11,9
WTRSL08G02		G 1/4"	5,5	18,0	22,8	17,0	13,8
WTRSL08G03		G 3/8"	6,5	19,5	22,8	20,0	21,2
WTRSL08G04		G 1/2"	7,5	20,5	22,8	24,0	23,9
WTRSL10G01	10	G 1/8"	4,8	24,3	26,3	14,0	21,3
WTRSL10G02		G 1/4"	5,5	23,1	26,3	17,0	24,3
WTRSL10G03		G 3/8"	6,5	21,5	26,3	20,0	27,6
WTRSL10G04		G 1/2"	7,5	22,5	26,3	24,0	31,2
WTRSL12G02	12	G 1/4"	5,5	26,5	29,6	17,0	33,8
WTRSL12G03		G 3/8"	6,5	23,0	29,6	20,0	35,6
WTRSL12G04		G 1/2"	7,5	24,0	29,6	24,0	39,8

WTRL-R

Swivel male elbow BSPT thread nickel plated

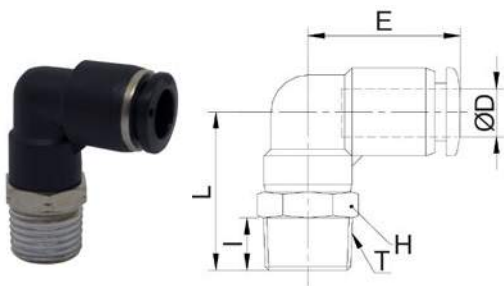

CODE	ØD	T	I	L	E	H	GR.
WTRL04R01	4	R 1/8"	7,0	23,5	17,5	10	8,1
WTRL04R02		R 1/4"	9,5	27,0	17,5	14	13,9
WTRL06R01	6	R 1/8"	7,0	25,2	19,0	12	11,5
WTRL06R02		R 1/4"	9,5	28,2	19,0	14	16,5
WTRL06R03		R 3/8"	10,5	29,7	19,0	17	22,6
WTRL06R04		R 1/2"	13,5	33,2	19,0	21	35,9
WTRL08R01	8	R 1/8"	7,0	26,5	22,8	14	17,6
WTRL08R02		R 1/4"	9,5	29,0	22,8	14	17,7
WTRL08R03		R 3/8"	10,5	30,5	22,8	17	25,3
WTRL08R04		R 1/2"	13,5	34,0	22,8	21	38,2
WTRL10R01	10	R 1/8"	7,0	29,5	26,3	17	30,7
WTRL10R02		R 1/4"	9,5	32,0	26,3	17	31,4
WTRL10R03		R 3/8"	10,5	33,0	26,3	17	30,8
WTRL10R04		R 1/2"	13,5	36,5	26,3	21	47,3
WTRL12R02	12	R 1/4"	9,5	35,5	29,6	20	44,3
WTRL12R03		R 3/8"	10,5	36,5	29,6	20	46,7
WTRL12R04		R 1/2"	13,5	39,5	29,6	21	51,2
WTRL14R03	14	R 3/8"	10,5	41,5	31,7	24	53,0
WTRL14R04		R 1/2"	13,5	45,5	31,7	24	62,0
WTRL16R03	16	R 3/8"	10,5	43,0	33,0	24	67,6
WTRL16R04		R 1/2"	13,5	46,0	33,0	24	72,8



WTRL-G

Swivel male elbow BSPP & metric thread nickel plated

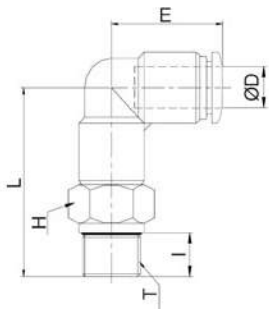

CODE	ØD	T	I	L	E	H	GR.
WTRL04M5	4	M5x0,8	3,8	17,3	17,5	8	5,1
WTRL04M6		M6x1	4,5	18,0	17,5	8	5,3
WTRL04G01		G 1/8"	5,0	24,0	17,5	14	11,8
WTRL04G02		G 1/4"	5,8	25,3	17,5	17	17,9
WTRL06M5	6	M5x0,8	3,8	17,3	19,0	8	5,8
WTRL06M6		M6x1	4,5	18,0	19,0	8	6,0
WTRL06G01		G 1/8"	5,0	25,2	19,0	14	14,6
WTRL06G02		G 1/4"	5,8	26,5	19,0	17	17,5
WTRL06G03		G 3/8"	6,8	28,0	19,0	20	24,4
WTRL06G04		G 1/2"	8,0	29,2	19,0	24	38,4
WTRL08G01	8	G 1/8"	5,0	26,0	22,8	14	17,5
WTRL08G02		G 1/4"	5,8	27,3	22,8	17	20,5
WTRL08G03		G 3/8"	6,8	28,8	22,8	20	26,6
WTRL08G04		G 1/2"	8,0	30	22,8	24	36,8
WTRL10G01	10	G 1/8"	5,0	29,0	26,3	17	31,2
WTRL10G02		G 1/4"	5,8	29,8	26,3	17	30,5
WTRL10G03		G 3/8"	6,8	31,3	26,3	20	34,6
WTRL10G04		G 1/2"	8,0	33,5	26,3	24	47,3
WTRL12G02	12	G 1/4"	5,8	33,8	29,6	20	43,9
WTRL12G03		G 3/8"	6,8	34,8	29,6	20	44,5
WTRL12G04		G 1/2"	8,0	36,5	29,6	24	51,8
WTRL14G03	14	G 3/8"	6,8	39,8	31,7	24	52,0
WTRL14G04		G 1/2"	8,0	41,5	31,7	24	61,0
WTRL16G03	16	G 3/8"	6,8	40,8	33,0	24	64,0
WTRL16G04		G 1/2"	8,0	42,0	33,0	24	66,5



WTRL-N

Swivel male elbow NPT & UNF thread nickel plated

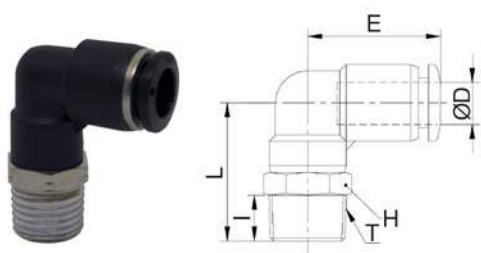

CODE	ØD	T	I	L	E	H	LB
WTRL532UF1032	5/32	UNF 10-32	0,149	0,681	0,688	0,314	0,016
WTRL532N01		N 1/8"	0,295	0,944	0,688	0,437	0,017
WTRL532N02		N 1/4"	0,413	1,102	0,688	0,562	0,030
WTRL316UF1032	3/16	UNF 10-32	0,149	0,866	0,700	0,437	0,016
WTRL316N01		N 1/8"	0,295	0,964	0,700	0,437	0,025
WTRL316N02		N 1/4"	0,413	1,102	0,700	0,562	0,034
WTRL316N03		N 3/8"	0,433	1,141	0,700	0,685	0,047
WTRL1-4UF1032	1/4	UNF 10-32	0,149	0,681	0,748	0,314	0,024
WTRL1-4N01		N 1/8"	0,295	1,011	0,748	0,5	0,025
WTRL1-4N02		N 1/4"	0,413	1,149	0,748	0,562	0,036
WTRL1-4N03		N 3/8"	0,433	1,188	0,748	0,685	0,049
WTRL516N01	5/16	N 1/8"	0,295	1,062	0,897	0,562	0,038
WTRL516N02		N 1/4"	0,413	1,181	0,897	0,562	0,039
WTRL516N03		N 3/8"	0,433	1,220	0,897	0,685	0,055
WTRL38N01	3/8	N 1/8"	0,295	1,181	1,035	0,685	0,067
WTRL38N02		N 1/4"	0,413	1,299	1,035	0,685	0,069
WTRL38N03		N 3/8"	0,433	1,318	1,035	0,685	0,067
WTRL38N04		N 1/2"	0,551	1,456	1,035	0,874	0,104
WTRL1-2N02	1/2	N 1/4"	0,413	1,437	1,165	0,874	0,097
WTRL1-2N03		N 3/8"	0,433	1,456	1,165	0,874	0,102
WTRL1-2N04		N 1/2"	0,551	1,574	1,165	0,874	0,112

WTRLL-R

Long swivel male elbow BSPT thread nickel plated

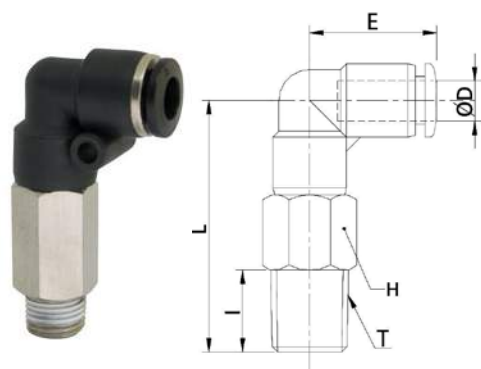

CODE	ØD	T	I	L	E	H	GR.
WTRLL04R01	4	R 1/8"	7,0	35,5	17,5	10,0	14,2
WTRLL04R02		R 1/4"	9,5	39,0	17,5	14,0	26,2
WTRLL06R01	6	R 1/8"	7,0	39,2	19,0	12,0	22,0
WTRLL06R02		R 1/4"	9,5	42,2	19,0	14,0	29,2
WTRLL06R03		R 3/8"	10,5	43,7	19,0	17,0	39,4
WTRLL06R04		R 1/2"	13,5	47,2	19,0	21,0	62,9
WTRLL08R01	8	R 1/8"	7,0	41,8	22,8	14,0	34,6
WTRLL08R02		R 1/4"	9,5	44,3	22,8	14,0	33,1
WTRLL08R03		R 3/8"	10,5	45,8	22,8	17,0	45,6
WTRLL08R04		R 1/2"	13,5	49,3	22,8	21,0	70,1
WTRLL10R01	10	R 1/8"	7,0	49,5	26,3	17,0	61,2
WTRLL10R02		R 1/4"	9,5	52,0	26,3	17,0	62,5
WTRLL10R03		R 3/8"	10,5	53,0	26,3	17,0	56,7
WTRLL10R04		R 1/2"	13,5	56,5	26,3	21,0	87,2
WTRLL12R02	12	R 1/4"	9,5	58,5	29,6	20,0	86,7
WTRLL12R03		R 3/8"	10,5	59,5	29,6	20,0	100,7
WTRLL12R04		R 1/2"	13,5	62,5	29,6	21,0	89,7



WTRLL-G

Long swivel male elbow BSPP & metric thread nickel plated

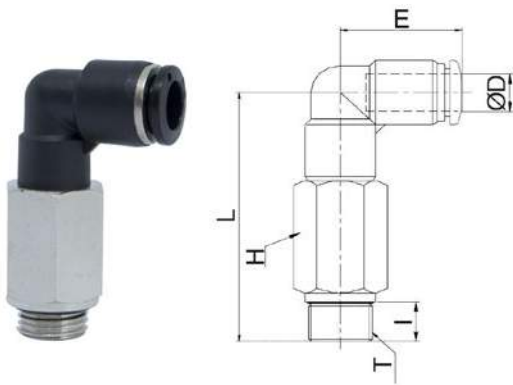

CODE	ØD	T	I	L	E	H	GR.
WTRLL04M5	4	M5x0,8	3,8	29,3	17,5	8,0	10,4
WTRLL04M6		M6x1	4,5	30,0	17,5	8,0	10,8
WTRLL04G01		G 1/8"	5,0	36,0	17,5	14,0	25,9
WTRLL04G02		G 1/4"	5,8	37,3	17,5	17,0	26,6
WTRLL06M5	6	M5x0,8	3,8	31,3	19,0	8,0	11,4
WTRLL06M6		M6x1	4,5	32,0	19,0	8,0	11,8
WTRLL06G01		G 1/8"	5,0	39,2	19,0	14,0	30,5
WTRLL06G02		G 1/4"	5,8	40,5	19,0	17,0	43,3
WTRLL06G03		G 3/8"	6,8	42,0	19,0	20,0	57,0
WTRLL06G04		G 1/2"	8,0	43,2	19,0	24,0	91,5
WTRLL08G01	8	G 1/8"	5,0	41,3	22,8	14,0	35,4
WTRLL08G02		G 1/4"	5,8	42,6	22,8	17,0	48,0
WTRLL08G03		G 3/8"	6,8	44,1	22,8	20,0	60,3
WTRLL08G04		G 1/2"	8,0	45,3	22,8	24,0	93,7
WTRLL10G01	10	G 1/8"	5,0	49,0	26,3	17,0	61,8
WTRLL10G02		G 1/4"	5,8	49,8	26,3	17,0	68,7
WTRLL10G03		G 3/8"	6,8	51,3	26,3	20,0	78,7
WTRLL10G04		G 1/2"	8,0	53,5	26,3	24,0	105,8
WTRLL12G02	12	G 1/4"	5,8	56,8	29,6	20,0	98,1
WTRLL12G03		G 3/8"	6,8	57,8	29,6	20,0	101,9
WTRLL12G04		G 1/2"	8,0	59,5	29,6	24,0	124,3

WTRLL-N

Long swivel male elbow NPT & UNF thread nickel plated

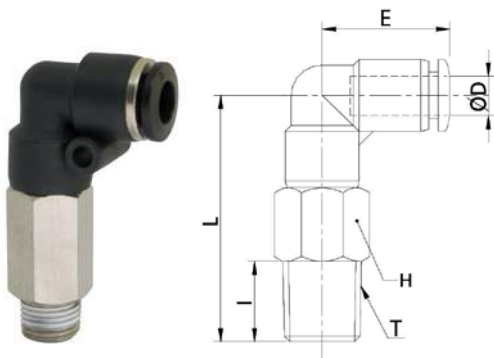

CODE	ØD	T	I	L	E	H	LB
WTRLL532UF1032	5/32	UNF10-32	0,149	1,318	0,688	0,437	0,029
WTRLL532N01		N 1/8"	0,295	1,417	0,688	0,437	0,031
WTRLL316N01	3/16	N 1/8"	0,295	1,417	0,700	0,437	0,046
WTRLL316N02		N 1/4"	0,413	1,555	0,700	0,562	0,061
WTRLL316N03		N 3/8"	0,433	1,594	0,700	0,685	0,082
WTRLL1-4N01	1/4	N 1/8"	0,295	1,562	0,748	0,5	0,048
WTRLL1-4N02		N 1/4"	0,413	1,700	0,748	0,562	0,064
WTRLL1-4N03		N 3/8"	0,433	1,740	0,748	0,685	0,086
WTRLL516N01	5/16	N 1/8"	0,295	1,665	0,897	0,562	0,076
WTRLL516N02		N 1/4"	0,413	1,783	0,897	0,562	0,073
WTRLL516N03		N 3/8"	0,433	1,822	0,897	0,685	0,100
WTRLL38N02	3/8	N 1/4"	0,413	2,047	1,035	0,685	0,137
WTRLL38N03		N 3/8"	0,433	2,106	1,035	0,685	0,125
WTRLL38N04		N 1/2"	0,551	2,244	1,035	0,874	0,192
WTRLL1-2N02	1/2	N 1/4"	0,413	2,342	1,165	0,874	0,191
WTRLL1-2N03		N 3/8"	0,433	2,362	1,165	0,874	0,222
WTRLL1-2N04		N 1/2"	0,551	2,480	1,165	0,874	0,197



WTRLH-R

Swivel male elbow 45° BSPT thread nickel plated

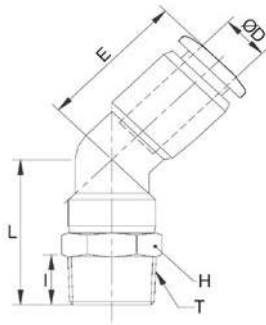

CODE	ØD	T	I	L	E	H	GR.
WTRLH04R01	4	R 1/8"	7,0	22,2	16,2	10	8,0
WTRLH04R02		R 1/4"	9,5	25,7	16,2	14	13,8
WTRLH06R01	6	R 1/8"	7,0	23,9	17,7	12	11,0
WTRLH06R02		R 1/4"	9,5	26,9	17,7	14	16,0
WTRLH06R03		R 3/8"	10,5	28,4	17,7	17	22,2
WTRLH06R04		R 1/2"	13,5	31,9	17,7	21	35,4
WTRLH08R01	8	R 1/8"	7,0	27,1	20,9	14	17,3
WTRLH08R02		R 1/4"	9,5	29,6	20,9	14	17,4
WTRLH08R03		R 3/8"	10,5	31,1	20,9	17	25,0
WTRLH08R04		R 1/2"	13,5	34,6	20,9	21	37,9
WTRLH10R01	10	R 1/8"	7,0	29,7	22,2	17	30,0
WTRLH10R02		R 1/4"	9,5	32,2	22,2	17	30,7
WTRLH10R03		R 3/8"	10,5	33,2	22,2	17	30,1
WTRLH10R04		R 1/2"	13,5	36,7	22,2	21	46,6
WTRLH12R02	12	R 1/4"	9,5	35,2	26,3	21	42,6
WTRLH12R03		R 3/8"	10,5	36,2	26,3	21	45,0
WTRLH12R04		R 1/2"	13,5	39,2	26,3	21	49,5

WTRLH-G

Swivel male elbow 45° BSPP & metric thread nickel plated

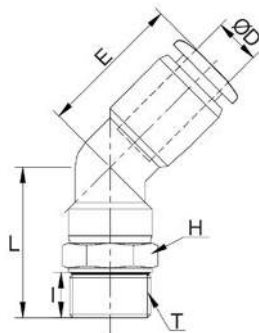

CODE	ØD	T	I	L	E	H	GR.	
WTRLH04M5	4	M5x0,8	3,8	20,0	16,2	10	8,1	
WTRLH04M6		M6x1	4,5	20,7	16,2	10	8,3	
WTRLH04G01		G 1/8"	5,0	22,7	16,2	14	11,7	
WTRLH04G02		G 1/4"	5,8	24,0	16,2	17	17,8	
WTRLH06M5	6	M5x0,8	3,8	21,7	17,7	12	10,8	
WTRLH06M6		M6x1	4,5	22,4	17,7	12	11,5	
WTRLH06G01		G 1/8"	5,0	23,9	17,7	14	14,2	
WTRLH06G02		G 1/4"	5,8	25,2	17,7	17	17,5	
WTRLH06G03	6	G 3/8"	6,8	26,7	17,7	20	24,0	
WTRLH06G04		G 1/2"	8,0	27,9	17,7	24	38,0	
WTRLH08G01		8	G 1/8"	5,0	26,6	20,9	14	17,2
WTRLH08G02			G 1/4"	5,8	27,9	20,9	17	20,2
WTRLH08G03	G 3/8"		6,8	29,4	20,9	20	26,3	
WTRLH08G04	G 1/2"		8,0	30,6	20,9	24	36,5	
WTRLH10G01	10	G 1/8"	5,0	29,2	22,2	17	30,6	
WTRLH10G02		G 1/4"	5,8	30,0	22,2	17	29,9	
WTRLH10G03		G 3/8"	6,8	31,5	22,2	20	34,0	
WTRLH10G04		G 1/2"	8,0	33,7	22,2	24	46,7	
WTRLH12G02	12	G 1/4"	5,8	33,5	26,3	21	42,4	
WTRLH12G03		G 3/8"	6,8	34,5	26,3	21	43,0	
WTRLH12G04		G 1/2"	8,0	36,2	26,3	24	50,3	



WTRLH-N

Swivel male elbow 45° NPT & UNF thread nickel plated

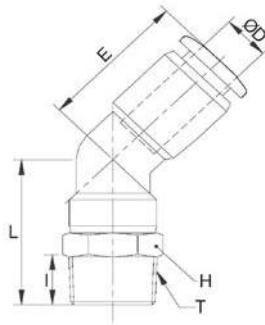

CODE	ØD	T	I	L	E	H	LB
WTRLH532UF1032	5/32	UNF 10-32	0,149	0,814	0,637	0,437	0,016
WTRLH532N01		N 1/8"	0,295	0,893	0,637	0,437	0,017
WTRLH532N02		N 1/4"	0,413	1,051	0,637	0,562	0,030
WTRLH316UF1032	3/16	UNF 10-32	0,149	0,814	0,649	0,437	0,023
WTRLH316N01		N 1/8"	0,295	0,913	0,649	0,437	0,024
WTRLH316N02		N 1/4"	0,413	1,051	0,649	0,562	0,033
WTRLH316N03		N 3/8"	0,433	1,090	0,649	0,685	0,046
WTRLH1-4UF1032	1/4	UNF 10-32	0,149	0,909	0,696	0,5	0,023
WTRLH1-4N01		N 1/8"	0,295	0,960	0,696	0,5	0,024
WTRLH1-4N02		N 1/4"	0,413	1,097	0,696	0,562	0,035
WTRLH1-4N03		N 3/8"	0,433	1,137	0,696	0,685	0,049
WTRLH516N01	5/16	N 1/8"	0,295	1,086	0,822	0,562	0,038
WTRLH516N02		N 1/4"	0,413	1,204	0,822	0,562	0,038
WTRLH516N03		N 3/8"	0,433	1,244	0,822	0,685	0,055
WTRLH38N01	3/8	N 1/8"	0,295	1,118	0,874	0,685	0,066
WTRLH38N02		N 1/4"	0,413	1,307	0,874	0,685	0,067
WTRLH38N03		N 3/8"	0,433	1,326	0,874	0,685	0,066
WTRLH38N04		N 1/2"	0,551	1,464	0,874	0,874	0,102
WTRLH1-2N02	1/2	N 1/4"	0,413	1,425	1,035	0,874	0,093
WTRLH1-2N03		N 3/8"	0,433	1,444	1,035	0,874	0,99
WTRLH1-2N04		N 1/2"	0,551	1,562	1,035	0,874	0,109

WTRLF-G

Swivel female elbow BSPP & metric thread nickel plated

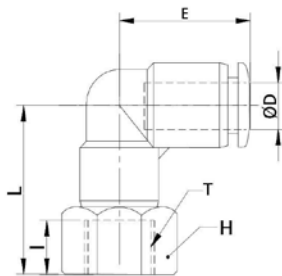

CODE	ØD	T	I	L	E	H	GR.
WTRLF04M5	4	M5x0,8	4,5	19,5	17,5	10,0	7,4
WTRLF04M6		M6x1	5,0	20,0	17,5	10,0	7,2
WTRLF04G01		G 1/8"	7,0	23,0	17,5	14,0	13,9
WTRLF04G02		G 1/4"	9,0	25,0	17,5	17,0	18,2
WTRLF06M5	6	M5x0,8	4,5	20,7	19,0	12,0	10,6
WTRLF06M6		M6x1	5,0	21,2	19,0	12,0	10,4
WTRLF06G01		G 1/8"	7,0	24,4	19,0	14,0	16,4
WTRLF06G02		G 1/4"	9,0	26,4	19,0	17,0	21,3
WTRLF06G03		G 3/8"	10,0	27,7	19,0	19,0	30,0
WTRLF08G01	8	G 1/8"	7,0	24,8	22,8	14,0	19,4
WTRLF08G02		G 1/4"	9,0	27,0	22,8	17,0	24,1
WTRLF08G03		G 3/8"	10,0	28,5	22,8	19,0	32,4
WTRLF08G04		G 1/2"	12,0	30,5	22,8	24,0	41,6
WTRLF10G01	10	G 1/8"	7,0	23,0	26,3	17,0	27,7
WTRLF10G02		G 1/4"	9,0	29,5	26,3	17,0	33,8
WTRLF10G03		G 3/8"	10,0	31,0	26,3	19,0	34,3
WTRLF10G04		G 1/2"	12,0	33,5	26,3	24,0	51,2
WTRLF12G02	12	G 1/4"	9,0	26,0	29,6	21,0	36,7
WTRLF12G03		G 3/8"	10,0	34,0	29,6	21,0	49,2
WTRLF12G04		G 1/2"	12,0	36,5	29,6	24,0	54,7



WTRLF-N

Swivel female elbow NPT thread nickel plated

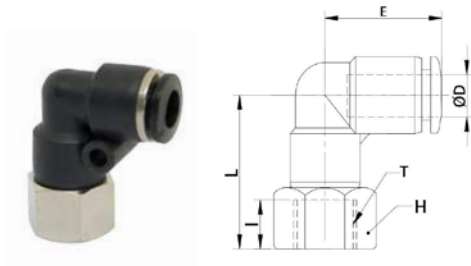

CODE	ØD	T	I	L	E	H	LB
WTRLF532N01	5/32	N 1/8"	0,295	0,925	0,688	0,562	0,030
WTRLF316N01	3/16	N 1/8"	0,295	0,937	0,700	0,562	0,034
WTRLF316N02		N 1/4"	0,413	1,043	0,700	0,685	0,044
WTRLF1-4N01	1/4	N 1/8"	0,295	0,980	0,748	0,562	0,036
WTRLF1-4N02		N 1/4"	0,413	1,098	0,748	0,685	0,047
WTRLF516N01	5/16	N 1/8"	0,295	0,984	0,897	0,562	0,042
WTRLF516N02		N 1/4"	0,413	1,122	0,897	0,685	0,053
WTRLF516N03		N 3/8"	0,433	1,161	0,897	0,874	0,071
WTRLF38N02	3/8	N 1/4"	0,413	1,220	1,035	0,685	0,074
WTRLF38N03		N 3/8"	0,433	1,240	1,035	0,874	0,075
WTRLF1-2N03	1/2	N 3/8"	0,433	1,358	1,165	0,874	0,108
WTRLF1-2N04		N 1/2"	0,551	1,476	1,165	1	0,120

WTRLM

Bulkhead elbow nickel plated

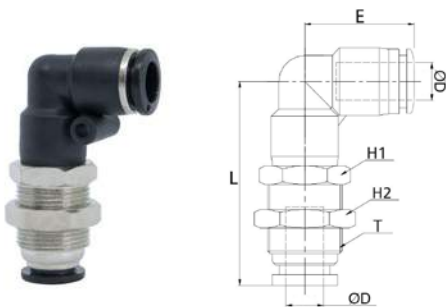

CODE	ØD	T	L	E	H1	H2	GR.
WTRLM04	4	M12x1	28,5	17,5	14	14	15,0
WTRLM06	6	M14x1	34,1	19,0	17	17	27,2
WTRLM08	8	M16x1	43,4	22,8	17	19	38,0
WTRLM10	10	M20x1	45,5	26,3	21	24	55,0
WTRLM12	12	M22x1	51,6	29,6	24	27	85,0

WTRH-R

Swivel male banjo elbow BSPT thread nickel plated

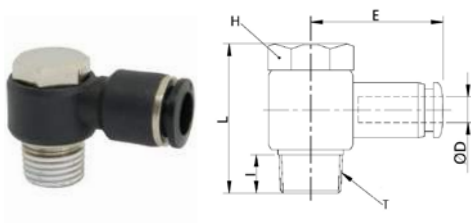

CODE	ØD	T	I	L	E	H	GR.
WTRH04R01	4	R 1/8"	7,0	23,0	22,3	10	10,5
WTRH04R02		R 1/4"	9,5	26,3	24,05	14	21,9
WTRH06R01	6	R 1/8"	7,0	23,0	23,1	10	11,0
WTRH06R02		R 1/4"	9,5	26,3	25,1	14	22,5
WTRH06R03		R 3/8"	10,5	31,9	26,8	19	37,8
WTRH08R01	8	R 1/8"	7,0	23,0	25,6	10	11,8
WTRH08R02		R 1/4"	9,5	26,3	28,6	14	23,3
WTRH08R03		R 3/8"	10,5	31,9	29,6	19	38,4
WTRH08R04		R 1/2"	13,5	38,6	32,6	24	75,4
WTRH10R02	10	R 1/4"	9,5	26,3	31,0	14	26,7
WTRH10R03		R 3/8"	10,5	31,9	31,6	19	41,8
WTRH10R04		R 1/2"	13,5	38,6	34,6	24	78,8
WTRH12R02	12	R 1/4"	9,5	26,3	33,5	14	28,2
WTRH12R03		R 3/8"	10,5	31,9	35,6	19	43,4
WTRH12R04		R 1/2"	13,5	38,6	36,6	24	80,3



WTRH-G

Swivel male banjo elbow BSPP & metric thread nickel plated

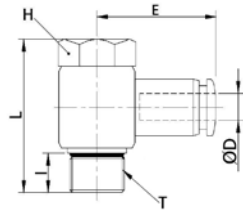

CODE	ØD	T	I	L	E	H	GR.
WTRH04M5	4	M5x0,8	4,0	18,0	20,0	8	6,6
WTRH04M6		M6x1	4,5	18,5	20,0	8	11,8
WTRH04G01		G 1/8"	5,0	22,5	22,3	10	11,5
WTRH06M5	6	M5x0,8	4,0	18,0	21,9	8	7,2
WTRH06M6		M6x1	4,5	18,5	21,9	8	12,4
WTRH06G01		G 1/8"	5,0	22,5	23,1	10	12,0
WTRH06G02		G 1/4"	5,8	26,2	25,15	14	23,0
WTRH08G01	8	G 1/8"	5,0	22,5	25,6	10	12,8
WTRH08G02		G 1/4"	5,8	26,2	28,65	14	23,8
WTRH08G03		G 3/8"	6,8	31,7	29,6	19	40,9
WTRH10G02	10	G 1/4"	5,8	26,2	31,05	14	27,2
WTRH10G03		G 3/8"	6,8	31,7	31,6	19	44,3
WTRH12G03	12	G 3/8"	6,8	31,7	35,6	19	45,9
WTRH12G04		G 1/2"	8,0	31,7	36,6	24	79,3

WTRH-N

Swivel male banjo elbow NPT & UNF thread nickel plated

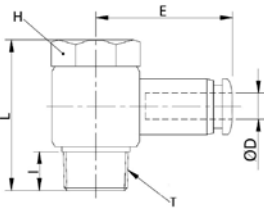

CODE	ØD	T	I	L	E	H	LB
WTRH532UF1032	5/32	UNF 10-32	0,149	0,700	0,787	0,314	0,022
WTRH532N01		N 1/8"	0,295	0,925	0,877	0,437	0,023
WTRH316UF1032	3/16	UNF 10-32	0,149	0,700	0,799	0,314	0,023
WTRH316N01		N 1/8"	0,295	0,925	0,889	0,437	0,024
WTRH316N02		N 1/4"	0,413	1,074	0,956	0,562	0,049
WTRH1-4N01	1/4	N 1/8"	0,295	1,043	0,909	0,437	0,024
WTRH1-4N02		N 1/4"	0,413	1,074	0,988	0,562	0,049
WTRH516N01	5/16	N 1/8"	0,295	0,925	1,007	0,437	0,026
WTRH516N02		N 1/4"	0,413	1,074	1,125	0,562	0,051
WTRH516N03		N 3/8"	0,433	1,275	1,165	0,748	0,084
WTRH38N02	3/8	N 1/4"	0,413	1,074	1,220	0,562	0,058
WTRH38N03		N 3/8"	0,433	1,275	1,244	0,748	0,092
WTRH1-2N03	1/2	N 3/8"	0,433	1,275	1,401	0,748	0,095
WTRH1-2N04		N 1/2"	0,551	1,539	1,440	1	0,177



WTRHF-R

Swivel female banjo elbow BSPT thread nickel plated

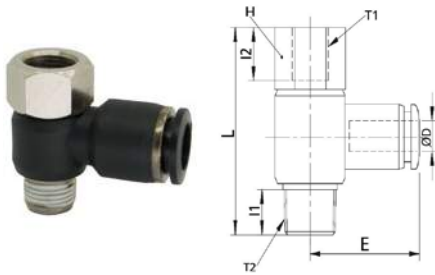

CODE	ØD	T1	T2	I1	I2	H	L	E	GR.
WTRHF04R01	4	G 1/8"	R 1/8"	7,0	7,0	14	29,0	22,3	16,4
WTRHF04R02		G 1/4"	R 1/4"	9,5	9,0	17	33,3	24,1	27,4
WTRHF06R01	6	G 1/8"	R 1/8"	7,0	7,0	14	29,0	23,1	17,0
WTRHF06R02		G 1/4"	R 1/4"	9,5	9,0	17	33,3	25,1	28,0
WTRHF06R03		G 3/8"	R 3/8"	10,5	10,0	19	39,9	26,8	44,8
WTRHF08R01	8	G 1/8"	R 1/8"	7,0	7,0	14	29,0	25,6	17,8
WTRHF08R02		G 1/4"	R 1/4"	9,5	9,0	17	33,3	28,6	28,8
WTRHF08R03		G 3/8"	R 3/8"	10,5	10,0	19	39,9	29,6	45,4
WTRHF08R04		G 1/2"	R 1/2"	13,5	12,0	24	46,5	32,6	71,9
WTRHF10R02	10	G 1/4"	R 1/4"	9,5	9,0	17	33,3	31,0	32,2
WTRHF10R03		G 3/8"	R 3/8"	10,5	10,0	19	39,9	31,6	48,8
WTRHF10R04		G 1/2"	R 1/2"	13,5	12,0	24	46,5	34,6	75,3
WTRHF12R02	12	G 1/4"	R 1/4"	9,5	9,0	17	33,3	33,5	33,7
WTRHF12R03		G 3/8"	R 3/8"	10,5	10,0	19	39,9	35,6	50,4
WTRHF12R04		G 1/2"	R 1/2"	13,5	12,0	24	46,5	36,6	76,8

WTRHF-G

Swivel female banjo elbow BSPP & metric thread nickel plated

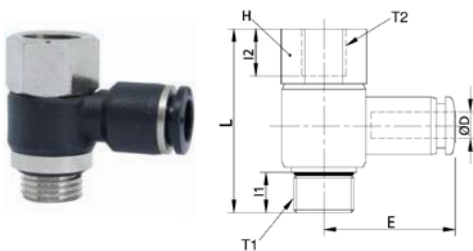

CODE	ØD	T1	T2	I1	I2	H	L	E	GR.
WTRHF04M5	4	M5x0,8	M5x0,8	4,0	5,5	10	20,5	20,0	8,3
WTRHF04M6		M6x1	M6x1	4,5	6,0	10	21,0	20,0	8,3
WTRHF04G01		G 1/8"	G 1/8"	5,5	7,0	14	30,0	22,3	18,4
WTRHF06M5	6	M5x0,8	M5x0,8	4,0	5,5	10	20,5	21,9	8,9
WTRHF06M6		M6x1	M6x1	4,5	6,0	10	21,0	21,9	8,9
WTRHF06G01		G 1/8"	G 1/8"	5,5	7,0	14	30,0	23,1	19,0
WTRHF06G02		G 1/4"	G 1/4"	6,5	9,0	17	33,7	25,1	30,5
WTRHF08G01	8	G 1/8"	G 1/8"	5,5	7,0	14	30,0	25,6	19,8
WTRHF08G02		G 1/4"	G 1/4"	6,5	9,0	17	33,7	28,6	31,3
WTRHF08G03		G 3/8"	G 3/8"	7,5	10,0	19	39,7	29,6	47,9
WTRHF10G02	10	G 1/4"	G 1/4"	6,5	9,0	17	33,7	31,1	34,7
WTRHF10G03		G 3/8"	G 3/8"	7,5	10,0	19	39,7	31,6	51,3
WTRHF12G03	12	G 3/8"	G 3/8"	7,5	10,0	19	39,7	35,6	52,9
WTRHF12G04		G 1/2"	G 1/2"	9,0	12,0	24	45,0	36,6	77,3



WTRHF-N

Swivel female banjo elbow NPT & UNF thread nickel plated

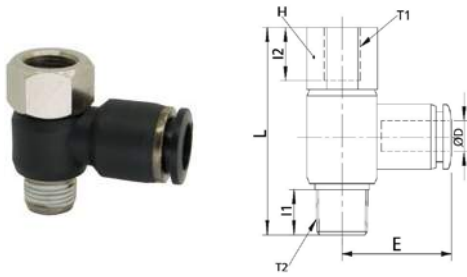

CODE	ØD	T1	T2	I1	I2	H	B	E	LB
WTRHF532UF1032	5/32	UNF 10-32	UNF 10-32	0,149	0,216	0,437	0,767	0,787	0,034
WTRHF532N01		N 1/8"	N 1/8"	0,295	0,295	0,562	1,181	0,877	0,036
WTRHF532UF1032	3/16	UNF 10-32	UNF 10-32	0,149	0,216	0,437	0,767	0,799	0,035
WTRHF316N01		N 1/8"	N 1/8"	0,295	0,295	0,562	1,181	0,889	0,037
WTRHF316N02		N 1/4"	N 1/4"	0,413	0,413	0,685	1,409	0,956	0,061
WTRHF1-4N01	1/4	N 1/8"	N 1/8"	0,295	0,295	0,562	1,181	0,909	0,037
WTRHF1-4N02		N 1/4"	N 1/4"	0,413	0,413	0,685	1,409	0,988	0,061
WTRHF516N01	5/16	N 1/8"	N 1/8"	0,295	0,295	0,562	1,181	1,007	0,039
WTRHF516N02		N 1/4"	N 1/4"	0,413	0,413	0,685	1,409	1,125	0,063
WTRHF516N03		N 3/8"	N 3/8"	0,433	0,433	0,874	1,610	1,165	0,100
WTRHF38N02	3/8	N 1/4"	N 1/4"	0,413	0,413	0,685	1,409	1,220	0,070
WTRHF38N03		N 3/8"	N 3/8"	0,433	0,433	0,874	1,610	1,244	0,107
WTRHF1-2N03	1/2	N 3/8"	N 3/8"	0,433	0,433	0,874	1,610	1,401	0,111
WTRHF1-2N04		N 1/2"	N 1/2"	0,551	0,551	1	1,929	1,440	0,170

WTRT-R

Swivel male central tee BSPT thread nickel plated

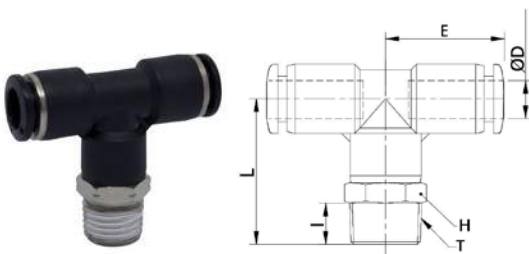

CODE	ØD	T	I	L	E	H	GR.
WTRT04R01	4	R 1/8"	7,0	24,5	18,5	10	10,5
WTRT04R02		R 1/4"	9,5	28,0	18,5	14	16,3
WTRT06R01	6	R 1/8"	7,0	25,5	19,3	12	14,1
WTRT06R02		R 1/4"	9,5	28,5	19,3	14	19,1
WTRT06R03		R 3/8"	10,5	30,0	19,3	17	25,2
WTRT06R04		R 1/2"	13,5	33,5	19,3	21	38,5
WTRT08R01	8	R 1/8"	7,0	29,0	22,75	14	20,9
WTRT08R02		R 1/4"	9,5	31,45	22,75	14	21,0
WTRT08R03		R 3/8"	10,5	32,95	22,75	17	28,6
WTRT08R04		R 1/2"	13,5	36,45	22,75	21	41,5
WTRT10R01	10	R 1/8"	7,0	34,5	27,0	17	37,9
WTRT10R02		R 1/4"	9,5	37,0	27,0	17	38,6
WTRT10R03		R 3/8"	10,5	38,0	27,0	17	38,0
WTRT10R04		R 1/2"	13,5	41,5	27,0	21	54,5
WTRT12R02	12	R 1/4"	9,5	38,5	29,6	20	52,8
WTRT12R03		R 3/8"	10,5	39,5	29,6	20	55,2
WTRT12R04		R 1/2"	13,5	42,5	29,6	21	59,7
WTRT16R03	16	R 3/8"	10,5	43,0	33,0	24	81,0
WTRT16R04		R 1/2"	13,5	46,0	33,0	24	85,5



WTRT-G

Swivel male central tee BSPP & metric thread nickel plated



CODE	ØD	T	I	L	E	H	GR.
WTRT04M5	4	M5x0,8	3,8	22,3	18,5	10	10,6
WTRT04M6		M6x1	4,5	23,0	18,5	10	10,8
WTRT04G01		G 1/8"	5,0	25,0	18,5	14	14,2
WTRT04G02		G 1/4"	5,8	26,3	18,5	17	20,3
WTRT06M5	6	M5x0,8	3,8	23,3	19,3	12	13,9
WTRT06M6		M6x1	4,5	24,0	19,3	12	14,6
WTRT06G01		G 1/8"	5,0	25,5	19,3	14	17,2
WTRT06G02		G 1/4"	5,8	26,8	19,3	17	20,5
WTRT06G03		G 3/8"	6,8	28,3	19,3	20	27,0
WTRT06G04		G 1/2"	8,0	29,5	19,3	24	41,0
WTRT08G01	8	G 1/8"	5,0	28,45	22,75	14	20,8
WTRT08G02		G 1/4"	5,8	29,75	22,75	17	23,8
WTRT08G03		G 3/8"	6,8	31,25	22,75	20	29,9
WTRT08G04		G 1/2"	8,0	32,45	22,75	24	40,1
WTRT10G01	10	G 1/8"	5,0	34,0	27,0	17	38,4
WTRT10G02		G 1/4"	5,8	34,8	27,0	17	37,7
WTRT10G03		G 3/8"	6,8	36,3	27,0	20	41,8
WTRT10G04		G 1/2"	8,0	38,5	27,0	24	54,5
WTRT12G02	12	G 1/4"	5,8	36,8	29,6	21	52,4
WTRT12G03		G 3/8"	6,8	37,8	29,6	21	53,0
WTRT12G04		G 1/2"	8,0	39,5	29,6	24	60,3
WTRT14G03	14	G 3/8"	6,8	39,8	31,7	21	61,0
WTRT14G04		G 1/2"	8,0	41,5	31,7	24	69,0
WTRT16G03	16	G 3/8"	6,8	40,8	33,0	24	76,6
WTRT16G04		G 1/2"	8,0	42,0	33,0	24	79,4



WTRT-N

Swivel male central tee NPT & UNF thread nickel plated

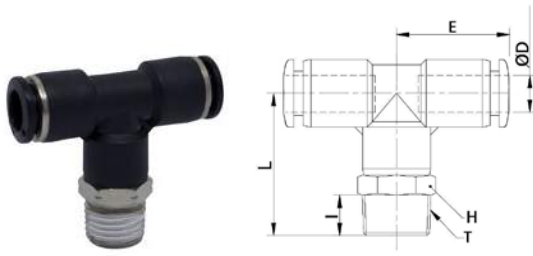

CODE	ØD	T	I	L	E	H	LB
WTRT532UF1032	5/32	UNF 10-32	0,149	0,905	0,728	0,437	0,022
WTRT532N01		N 1/8"	0,295	0,984	0,728	0,437	0,023
WTRT532N02		N 1/4"	0,413	1,141	0,728	0,562	0,036
WTRT316UF1032	3/16	UNF 10-32	0,149	0,905	0,740	0,437	0,028
WTRT316N01		N 1/8"	0,295	1,003	0,740	0,437	0,029
WTRT316N02		N 1/4"	0,413	1,141	0,740	0,562	0,040
WTRT316N03		N 3/8"	0,433	1,181	0,740	0,685	0,052
WTRT1-4UF1032	1/4	UNF 10-32	0,149	0,972	0,759	0,5	0,029
WTRT1-4N01		N 1/8"	0,295	1,023	0,759	0,5	0,031
WTRT1-4N02		N 1/4"	0,413	1,161	0,759	0,562	0,042
WTRT1-4N03		N 3/8"	0,433	1,200	0,759	0,685	0,055
WTRT516N01	5/16	N 1/8"	0,295	1,159	0,895	0,562	0,046
WTRT516N02		N 1/4"	0,413	1,277	0,895	0,562	0,046
WTRT516N03		N 3/8"	0,433	1,316	0,895	0,685	0,063
WTRT38N01	3/8	N 1/8"	0,295	1,377	1,062	0,685	0,083
WTRT38N02		N 1/4"	0,413	1,496	1,062	0,685	0,085
WTRT38N03		N 3/8"	0,433	1,515	1,062	0,685	0,083
WTRT38N04		N 1/2"	0,551	1,653	1,062	0,874	0,120
WTRT1-2N02	1/2	N 1/4"	0,413	1,555	1,165	0,874	0,116
WTRT1-2N03		N 3/8"	0,433	1,574	1,165	0,874	0,121
WTRT1-2N04		N 1/2"	0,551	1,692	1,165	0,874	0,131

WTRST-R

Swivel lateral male tee BSPT thread nickel plated

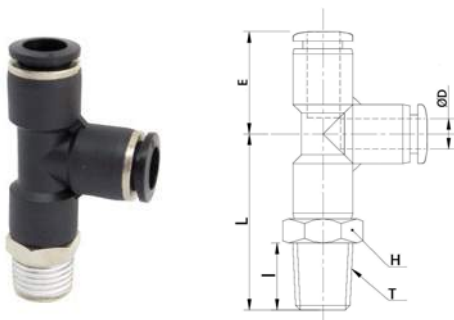

CODE	ØD	T	I	L	E	H	GR.
WTRTST04R01	4	R 1/8"	7,0	24,5	18,5	10	10,5
WTRTST04R02		R 1/4"	9,5	28,0	18,5	14	16,3
WTRTST06R01	6	R 1/8"	7,0	25,5	19,3	12	14,1
WTRTST06R02		R 1/4"	9,5	28,5	19,3	14	19,1
WTRTST06R03		R 3/8"	10,5	30,0	19,3	17	25,2
WTRTST06R04		R 1/2"	13,5	33,5	19,3	21	38,5
WTRTST08R01	8	R 1/8"	7,0	29,0	22,75	14	20,9
WTRTST08R02		R 1/4"	9,5	31,45	22,75	14	21,0
WTRTST08R03		R 3/8"	10,5	32,95	22,75	17	28,6
WTRTST08R04		R 1/2"	13,5	36,45	22,75	21	41,5
WTRTST10R01	10	R 1/8"	7,0	34,5	27,0	17	37,9
WTRTST10R02		R 1/4"	9,5	37,0	27,0	17	38,6
WTRTST10R03		R 3/8"	10,5	38,0	27,0	17	38,0
WTRTST10R04		R 1/2"	13,5	41,5	27,0	21	54,5
WTRTST12R02	12	R 1/4"	9,5	38,5	29,6	20	52,8
WTRTST12R03		R 3/8"	10,5	39,5	29,6	20	55,2
WTRTST12R04		R 1/2"	13,5	42,5	29,6	21	59,7



WTRST-G

Swivel male lateral tee BSPP & metric thread nickel plated

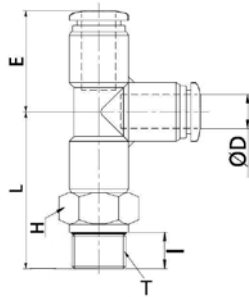

CODE	ØD	T	I	L	E	H	GR.
WTRST04M5	4	M5x0,8	3,8	22,3	18,5	10	10,6
WTRST04M6		M6x1	4,5	23,0	18,5	10	10,8
WTRST04G01		G 1/8"	5,0	25,0	18,5	14	14,2
WTRST04G02		G 1/4"	5,8	26,3	18,5	17	20,3
WTRST06M5	6	M5x0,8	3,8	23,3	19,3	12	13,9
WTRST06M6		M6x1	4,5	24,0	19,3	12	14,6
WTRST06G01		G 1/8"	5,0	25,5	19,3	14	17,2
WTRST06G02		G 1/4"	5,8	26,8	19,3	17	20,5
WTRST06G03	6	G 3/8"	6,8	28,3	19,3	12	27,0
WTRST06G04		G 1/2"	8,0	29,5	19,3	12	41,0
WTRST08G01		G 1/8"	5,0	28,45	22,75	14	20,8
WTRST08G02		G 1/4"	5,8	29,75	22,75	17	23,8
WTRST08G03	8	G 3/8"	6,8	31,25	22,75	20	29,9
WTRST08G04		G 1/2"	8,0	32,45	22,75	24	40,1
WTRST10G01		G 1/8"	5,0	34,0	27,0	17	38,4
WTRST10G02		G 1/4"	5,8	34,8	27,0	17	37,7
WTRST10G03	10	G 3/8"	6,8	36,3	27,0	20	41,8
WTRST10G04		G 1/2"	8,0	38,5	27,0	24	54,5
WTRST12G02		G 1/4"	5,8	36,8	29,6	21	52,4
WTRST12G03		G 3/8"	6,8	37,8	29,6	21	53,0
WTRST12G04	12	G 1/2"	8,0	39,5	29,6	24	60,3

WTRST-N

Swivel lateral male tee NPT & UNF nickel plated

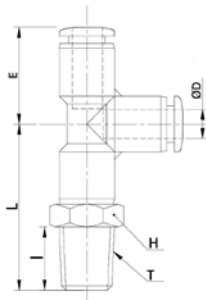

CODE	ØD	T	I	L	E	H	LB
WTRST532UF1032	5/32	UNF 10-32	0,149	0,905	0,728	0,437	0,022
WTRST532N01		N 1/8"	0,295	0,984	0,728	0,437	0,023
WTRST532N02		N 1/4"	0,413	1,141	0,728	0,562	0,036
WTRST316UF1032	3/16	UNF 10-32	0,149	0,905	0,740	0,437	0,029
WTRST316N01		N 1/8"	0,295	1,003	0,740	0,437	0,031
WTRST316N02		N 1/4"	0,413	1,141	0,740	0,562	0,040
WTRST316N03		N 3/8"	0,433	1,181	0,740	0,685	0,052
WTRST1-4UF1032	1/4	UNF 10-32	0,149	0,972	0,759	0,5	0,031
WTRST1-4N01		N 1/8"	0,295	1,023	0,759	0,5	0,032
WTRST1-4N02		N 1/4"	0,413	1,161	0,759	0,562	0,042
WTRST1-4N03		N 3/8"	0,433	1,200	0,759	0,685	0,055
WTRST516N01	5/16	N 1/8"	0,295	1,159	0,895	0,562	0,046
WTRST516N02		N 1/4"	0,413	1,277	0,895	0,562	0,046
WTRST516N03		N 3/8"	0,433	1,316	0,895	0,685	0,063
WTRST38N01	3/8	N 1/8"	0,295	1,377	1,062	0,685	0,083
WTRST38N02		N 1/4"	0,413	1,496	1,062	0,685	0,085
WTRST38N03		N 3/8"	0,433	1,515	1,062	0,685	0,083
WTRST38N04		N 1/2"	0,551	1,653	1,062	0,874	0,120
WTRST1-2N02	1/2	N 1/4"	0,413	1,555	1,165	0,874	0,116
WTRST1-2N03		N 3/8"	0,433	1,574	1,165	0,874	0,121
WTRST1-2N04		N 1/2"	0,551	1,692	1,165	0,874	0,131



WTRWT-R

Swivel male Y BSPT thread nickel plated

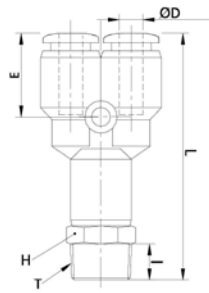

CODE	ØD	T	I	L	E	H	GR.
WTRWT04R01	4	R 1/8"	7,0	41,5	14,0	10	10,7
WTRWT04R02		R 1/4"	9,5	45,0	14,0	14	16,6
WTRWT06R01	6	R 1/8"	7,0	43,3	14,8	12	14,6
WTRWT06R02		R 1/4"	9,5	46,3	14,8	14	19,6
WTRWT06R03		R 3/8"	10,5	47,8	14,8	17	25,8
WTRWT06R04		R 1/2"	13,5	51,3	14,8	21	39,0
WTRWT08R01	8	R 1/8"	7,0	46,6	18,2	14	21,0
WTRWT08R02		R 1/4"	9,5	49,1	18,2	14	21,1
WTRWT08R03		R 3/8"	10,5	50,6	18,2	17	28,7
WTRWT08R04		R 1/2"	13,5	54,1	18,2	21	41,6
WTRWT10R01	10	R 1/8"	7,0	54,6	19,5	17	38,3
WTRWT10R02		R 1/4"	9,5	57,1	19,5	17	39,0
WTRWT10R03		R 3/8"	10,5	58,1	19,5	17	38,4
WTRWT10R04		R 1/2"	13,5	61,6	19,5	21	54,9
WTRWT12R02	12	R 1/4"	9,5	62,1	21,6	21	53,6
WTRWT12R03		R 3/8"	10,5	63,1	21,6	21	46,0
WTRWT12R04		R 1/2"	13,5	66,1	21,6	21	60,5

WTRWT-G

Swivel male Y BSPP & metric thread nickel plated

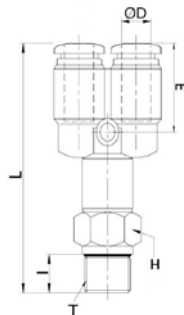

CODE	ØD	T	I	L	E	H	GR.
WTRWT04M5	4	M5x0,8	4,0	39,3	14,0	10	10,8
WTRWT04M6		M6x1	4,5	40,0	14,0	10	11,0
WTRWT04G01		G 1/8"	5,0	42,0	14,0	14	14,5
WTRWT04G02		G 1/4"	5,8	43,3	14,0	17	20,6
WTRWT06M5	6	M5x0,8	4,0	41,1	14,8	12	14,5
WTRWT06M6		M6x1	4,5	41,8	14,8	12	15,1
WTRWT06G01		G 1/8"	5,0	43,3	14,8	14	17,7
WTRWT06G02		G 1/4"	5,8	44,6	14,8	17	21,0
WTRWT06G03	6	G 3/8"	6,8	46,1	14,8	20	27,5
WTRWT06G04		G 1/2"	8,0	47,3	14,8	24	41,5
WTRWT08G01		G 1/8"	5,0	46,1	18,2	14	20,9
WTRWT08G02		G 1/4"	5,8	47,4	18,2	17	23,9
WTRWT08G03	8	G 3/8"	6,8	48,9	18,2	20	30,0
WTRWT08G04		G 1/2"	8,0	50,1	18,2	24	40,2
WTRWT10G01		G 1/8"	5,0	54,1	19,5	17	38,8
WTRWT10G02		G 1/4"	5,8	54,9	19,5	17	38,1
WTRWT10G03	10	G 3/8"	6,8	56,4	19,5	20	42,2
WTRWT10G04		G 1/2"	8,0	58,6	19,5	24	54,9
WTRWT12G02		G 1/4"	5,8	60,4	21,6	21	53,2
WTRWT12G03		G 3/8"	6,8	61,4	21,6	21	53,8
WTRWT12G04	12	G 1/2"	8,0	63,1	21,6	24	61,1



WTRWT-N

Swivel male Y NPT & UNF thread nickel plated

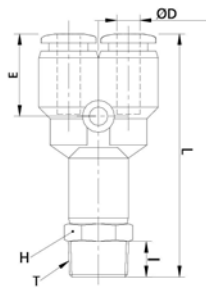

CODE	ØD	T	I	L	E	H	LB
WTRWT532UF1032	5/32	UNF 10-32	0,149	1,574	0,551	0,437	0,022
WTRWT532N01		N 1/8"	0,295	1,653	0,551	0,437	0,023
WTRWT532N02		N 1/4"	0,413	1,811	0,551	0,562	0,036
WTRWT316UF1032	3/16	UNF 10-32	0,149	1,586	0,562	0,437	0,030
WTRWT316N01		N 1/8"	0,295	1,760	0,562	0,437	0,032
WTRWT316N02		N 1/4"	0,413	1,822	0,562	0,562	0,041
WTRWT316N03		N 3/8"	0,433	1,862	0,562	0,685	0,054
WTRWT1-4UF1032	1/4	UNF 10-32	0,149	1,673	0,582	0,5	0,031
WTRWT1-4N01		N 1/8"	0,295	1,724	0,582	0,5	0,032
WTRWT1-4N02		N 1/4"	0,413	1,862	0,582	0,562	0,043
WTRWT1-4N03		N 3/8"	0,433	1,901	0,582	0,685	0,056
WTRWT516N01	5/16	N 1/8"	0,295	1,854	0,716	0,562	0,046
WTRWT516N02		N 1/4"	0,413	1,972	0,716	0,562	0,046
WTRWT516N03		N 3/8"	0,433	2,011	0,716	0,685	0,063
WTRWT38N01	3/8	N 1/8"	0,295	2,169	0,767	0,685	0,084
WTRWT38N02		N 1/4"	0,413	2,287	0,767	0,685	0,085
WTRWT38N03		N 3/8"	0,433	2,307	0,767	0,685	0,084
WTRWT38N04		N 1/2"	0,551	2,444	0,767	0,874	0,121
WTRWT1-2N02	1/2	N 1/4"	0,413	2,484	0,850	0,874	0,118
WTRWT1-2N03		N 3/8"	0,433	2,503	0,850	0,874	0,101
WTRWT1-2N04		N 1/2"	0,551	2,622	0,850	0,874	0,133

WTRKD-R

Swivel multi-tee lateral male connector BSPT thread nickel plated

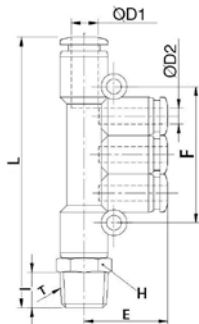

CODE	ØD1	ØD2	T	E	F	L	I	H	GR.
WTRKD0604R01	6	4	R 1/8"	19,0	36	63,8	7,0	12	17,4
WTRKD0804R02	8	4	R 1/4"	20,0	42	71,3	9,5	14	23,1
WTRKD0806R02	8	6	R 1/4"	20,3	42	71,3	9,5	14	24,2
WTRKD1008R03	10	8	R 3/8"	24,3	48	91,0	10,5	17	40,2

WTRKD-G

Swivel multi-tee lateral male connector BSPP thread nickel plated

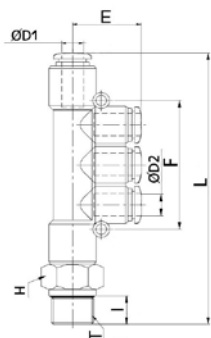

CODE	ØD1	ØD2	T	E	F	L	I	H	GR.
WTRKD0604G01	6	4	G 1/8"	19,0	36	63,8	5,0	14	20,5
WTRKD0804G02	8	4	G 1/4"	20,0	42	69,6	5,8	17	26,0
WTRKD0806G02	8	6	G 1/4"	20,3	42	69,6	5,8	17	27,0
WTRKD1008G03	10	8	G 3/8"	24,3	48	89,3	6,8	20	44,0



WTRKD-N

Swivel multi-tee lateral male connector NPT thread nickel plated

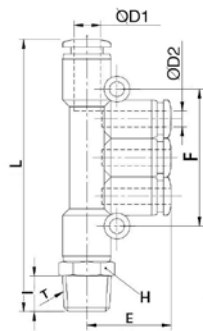

CODE	ØD1	ØD2	T	E	F	L	I	H	LB
WTRKD316-532N01	3/16	5/32	N 1/8"	0,748	1,417	2,531	0,295	0,437	0,036
WTRKD1-4-532-N01	1/4	5/32	N 1/8"	0,748	1,417	2,531	0,295	0,5	0,048
WTRKD516-532N02	5/16	5/32	N 1/4"	0,787	1,653	2,846	0,413	0,562	0,050
WTRKD516-316N02	5/16	3/16	N 1/4"	0,799	1,653	2,846	0,413	0,562	0,050
WTRKD516-1-4N02	5/16	1/4	N 1/4"	0,799	1,653	2,846	0,413	0,562	0,053
WTRKD38-516N03	3/8	5/16	N 3/8"	0,956	1,889	3,602	0,433	0,685	0,088

WTRUC

Union connector

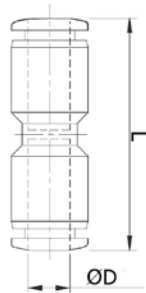

CODE	ØD	L	GR.
WTRUC0400	4	33,0	4,2
WTRUC0500	5	35,2	5,0
WTRUC0600	6	35,2	5,2
WTRUC0700	7	39,1	7,0
WTRUC0800	8	39,1	6,8
WTRUC0900	9	45,2	14,0
WTRUC1000	10	45,2	14,0
WTRUC1100	11	49,2	17,0
WTRUC1200	12	49,2	16,4
WTRUC1400	14	48,4	18,0
WTRUC1500	15	51,0	25,0
WTRUC1600	16	51,0	24,5

WTRUC-N

Union connector

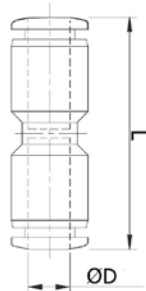

CODE	ØD	L	LB
WTRUC532	5/32	1,299	0,009
WTRUC316	3/16	1,322	0,010
WTRUC1-4	1/4	1,385	0,011
WTRUC516	5/16	1,539	0,014
WTRUC38	3/8	1,779	0,030
WTRUC-2	1/2	1,937	0,036



WTRG

Reduced union connector

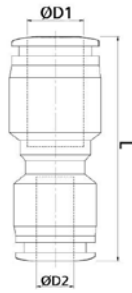

CODE	ØD1	ØD2	L	GR.
WTRG0604	6	4	33,6	5,2
WTRG0805	8	5	35,5	6,0
WTRG0806	8	6	36,1	6,8
WTRG1007	10	7	41,8	10,0
WTRG1008	10	8	41,8	12,7
WTRG1207	12	7	46,9	13,0
WTRG1208	12	8	46,9	14,1
WTRG1210	12	10	46,1	16,6
WTRG1410	14	10	46,7	17,0
WTRG1412	14	12	48,3	17,0
WTRG1610	16	10	48,5	24,3
WTRG1612	16	12	50,1	26,0
WTRG1614	16	14	50	28,0

WTRG-N

Reduced union connector

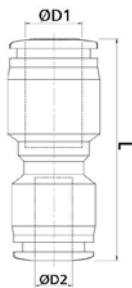

CODE	ØD1	ØD2	L	LB
WTRG316-532	3/16	5/32	1,311	0,014
WTRG1-4-532	1/4	5/32	1,374	0,010
WTRG1-4-316	1/4	3/16	1,385	0,011
WTRG516-1-4	5/16	1/4	1,519	0,014
WTRG38-516	3/8	5/16	1,862	0,027
WTRG1-2-38	1/2	3/8	1,925	0,036

WTRUL

Union elbow

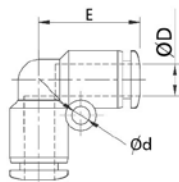

CODE	ØD	Ød	E	GR.
WTRUL0400	4	3,2	17,5	4,2
WTRUL0600	6	3,2	19,0	5,5
WTRUL0800	8	3,2	22,8	7,3
WTRUL1000	10	4,2	26,3	14,3
WTRUL1200	12	4,3	29,6	18,2
WTRUL1400	14	5,1	31,7	23,0
WTRUL1600	16	5,1	33,0	27,0



WTRUL-N

Union elbow

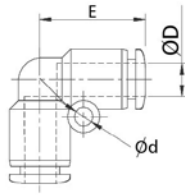

CODE	ØD	Ød	E	LB
WTRUL532	5/32	0,125	0,688	0,009
WTRUL316	3/16	0,125	0,700	0,011
WTRUL1-4	1/4	0,125	0,748	0,012
WTRUL516	5/16	0,125	0,897	0,016
WTRUL38	3/8	0,165	1,035	0,031
WTRUL1-2	1/2	0,169	1,165	0,040

WTRUT

Union tee

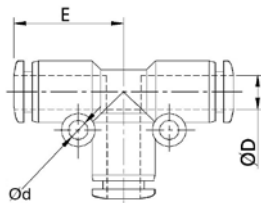

CODE	ØD	Ød	E	GR.
WTRUT0400	4	3,2	18,5	6,5
WTRUT0600	6	3,2	19,3	8,1
WTRUT0800	8	3,2	22,75	10,6
WTRUT1000	10	4,2	27,0	21,4
WTRUT1200	12	4,3	29,6	26,7
WTRUT1400	14	5,1	31,7	31,0
WTRUT1600	16	5,1	33,0	39,7

WTRUT-N

Union tee

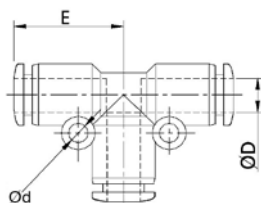

CODE	ØD	Ød	E	LB
WTRUT532	5/32	0,125	0,728	0,014
WTRUT316	3/16	0,125	0,740	0,016
WTRUT1-4	1/4	0,125	0,759	0,017
WTRUT516	5/16	0,125	0,895	0,023
WTRUT38	3/8	0,165	1,062	0,047
WTRUT1-2	1/2	0,169	1,165	0,058

WTRGT

Reduced union tee

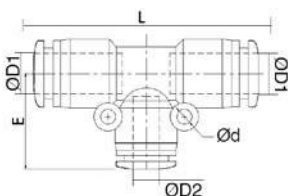

CODE	ØD1	ØD2	Ød	E	L	GR.
WTRGT0604	6	4	3,2	19,5	38,6	8,1
WTRGT0806	8	6	3,2	20,3	45,5	10,6
WTRGT1008	10	8	4,2	24,8	54,0	20,2
WTRGT1210	12	10	4,2	28,5	59,2	26,9
WTRGT1612	16	12	5,1	32,1	66,0	41,9



WTRGT-N

Reduced union tee

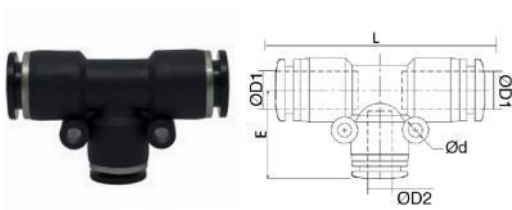

CODE	ØD1	ØD2	Ød	L	E	LB
WTRGT1-4-532	1/4	5/32	0,125	1,518	0,748	0,016
WTRGT516-1-4	5/16	1/4	0,125	1,79	0,877	0,023
WTRGT38-516	3/8	5/16	0,125	2,124	1,094	0,044
WTRGT1-2-38	1/2	3/8	0,165	2,33	1,153	0,059

WTRY

Union Y



CODE	ØD	Ød	L	F	GR.
WTRY0400	4	3,2	35,5	14,0	6,8
WTRY0600	6	3,2	37,1	14,8	8,6
WTRY0800	8	3,2	40,4	18,2	10,7
WTRY1000	10	4,2	47,1	19,5	21,8
WTRY1200	12	4,2	53,2	21,6	27,5
WTRY1600	16	5,1	61,0	23,5	33,5

WTRY-N

Union Y



CODE	ØD	Ød	L	F	LB
WTRY532	5/32	0,125	1,397	0,551	0,014
WTRY316	3/16	0,125	1,421	0,562	0,018
WTRY1-4	1/4	0,125	1,460	0,582	0,019
WTRY516	5/16	0,125	1,590	0,716	0,023
WTRY38	3/8	0,165	1,854	0,767	0,048
WTRY1-2	1/2	0,165	2,094	0,850	0,060

WTRW

Reduced union Y



CODE	ØD1	ØD2	Ød	L	F	GR.
WTRY0604	6	4	3,2	36,8	14,5	9,2
WTRY0806	8	6	3,2	39,9	17,7	11,4
WTRY1008	10	8	4,2	47,9	20,3	21,8
WTRY1210	12	10	4,2	51,6	20,0	29,3



WTRW-N

Reduced union Y

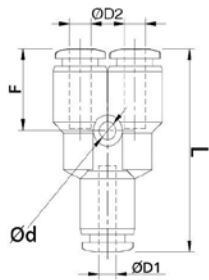

CODE	ØD1	ØD2	Ød	L	F	LB
WTRW316-532	3/16	5/32	0,125	1,409	0,551	0,019
WTRW1-4-532	1/4	5/32	0,125	1,448	0,570	0,020
WTRW1-4-316	1/4	3/16	0,125	1,460	0,582	0,021
WTRW516-1-4	5/16	1/4	0,125	1,570	0,696	0,025
WTRW38-516	3/8	5/16	0,165	1,885	0,799	0,048
WTRW1-2-38	1/2	3/8	0,165	2,031	0,787	0,064

WTRZA

Union cross

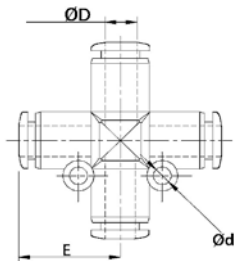

CODE	ØD	Ød	E	GR.
WTRZA0400	4	3,2	17,5	8,0
WTRZA0600	6	3,2	19,3	10,2
WTRZA0800	8	3,2	22,75	13,6
WTRZA1000	10	4,2	27,0	28,2
WTRZA1200	12	4,3	29,6	34,2

WTRZA-N

Union cross

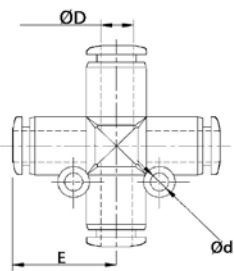

CODE	ØD	Ød	E	LB
WTRZA532	5/32	0,125	0,688	0,017
WTRZA316	3/16	0,125	0,700	0,021
WTRZA1-4	1/4	0,125	0,759	0,022
WTRZA516	5/16	0,125	0,895	0,029
WTRZA38	3/8	0,165	1,062	0,062
WTRZA1-2	1/2	0,169	1,165	0,075

WTRK

Union multi-tee

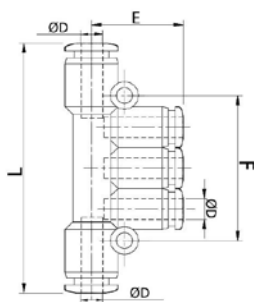

CODE	ØD	F	E	L	GR.
WTRK04	4	36	19	57,0	13,0
WTRK06	6	42	20,3	61,6	17,0
WTRK08	8	48	24,3	81,6	22,0



WTRK-N

Union multi-tee

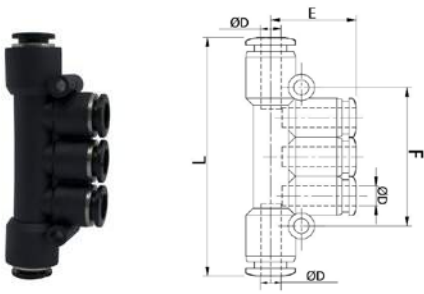

CODE	ØD	E	L	F	LB
WTRK532	5/32	0,748	2,244	1,417	0,028
WTRK316	3/16	0,759	2,267	1,417	0,035
WTRK1-4	1/4	0,799	2,425	1,653	0,037
WTRK516	5/16	0,956	3,173	1,889	0,048

WTRKG

Reduced union multi-tee

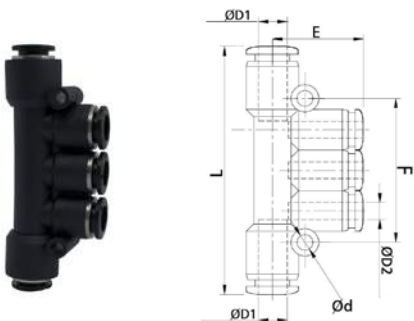

CODE	ØD1	ØD2	Ød	E	F	L	GR.
WTRKG0604	6	4	3,2	19,0	36	57,6	13,0
WTRKG0804	8	4	3,2	20,0	42	62,6	16,0
WTRKG0806	8	6	3,2	20,3	42	62,6	16,6
WTRKG1006	10	6	4,2	23,8	48	80,0	28,0
WTRKG1008	10	8	4,2	24,3	48	80,0	30,8

WTRKG-N

Reduced union multi-tee

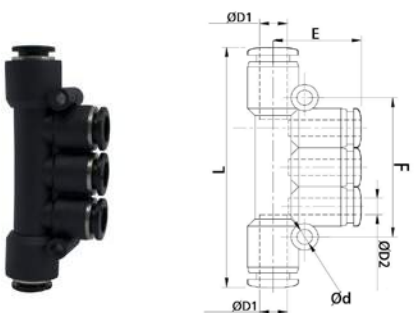

CODE	ØD1	ØD2	Ød	E	F	L	LB
WTRKG316-532	3/16	5/32	0,125	0,748	1,417	2,267	0,027
WTRKG1-4-532	1/4	5/32	0,125	0,748	1,417	2,267	0,028
WTRKG516-532	5/16	5/32	0,125	0,787	1,653	2,464	0,035
WTRKG516-1-4	5/16	1/4	0,125	0,799	1,653	2,464	0,036
WTRKG38-1-4	3/8	1/4	0,165	0,937	1,889	3,149	0,061
WTRKG38-516	3/8	5/16	0,165	0,956	1,889	3,149	0,067

WTRGJ

Reducer



CODE	ØD1	ØD2	L	GR.
WTRGJ0604	6	4	39,5	1,4
WTRGJ0804	8	4	41,5	2,7
WTRGJ0806	8	6	41,8	2,0
WTRGJ1006	10	6	46,8	3,8
WTRGJ1008	10	8	47,3	2,8
WTRGJ1206	12	6	51,8	7,7
WTRGJ1208	12	8	52,3	6,4
WTRGJ1210	12	10	51,5	4,2



WTRGJ-N

Reducer

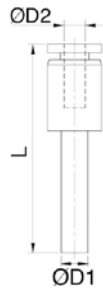

CODE	ØD1	ØD2	L	LB
WTRGJ1-4-532	1/4	5/32	1,555	0,003
WTRGJ516-532	5/16	5/32	1,633	0,005
WTRGJ516-1-4	5/16	1/4	1,645	0,004
WTRGJ38-1-4	3/8	1/4	1,830	0,008
WTRGJ38-516	3/8	5/16	1,830	0,006
WTRGJ1-2-1-4	1/2	1/4	2,039	0,016
WTRGJ1-2-516	1/2	5/16	2,059	0,014
WTRGJ1-2-38	1/2	3/8	2,027	0,009

WTRLJ

Elbow with stem

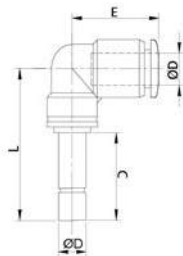

CODE	ØD	C	E	L	GR.
WTRLJ0400	4	16,0	17,5	33,0	6,5
WTRLJ0600	6	18,0	19,0	36,2	8,1
WTRLJ0800	8	21,0	22,8	40,0	10,6
WTRLJ1000	10	24,0	26,3	46,5	21,4
WTRLJ1200	12	26,0	29,6	51,5	26,7

WTRLJ-N

Elbow with stem

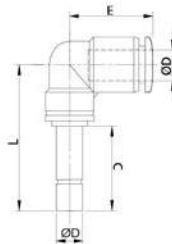

CODE	ØD	E	L	LB
WTRLJ532	5/32	0,688	1,299	0,014
WTRLJ316	3/16	0,700	1,299	0,016
WTRLJ1-4	1/4	0,748	1,425	0,017
WTRLJ516	5/16	0,897	1,673	0,023
WTRLJ38	3/8	1,035	2	0,047
WTRLJ1-2	1/2	1,165	2,145	0,058

WTRLGJ

Reduced elbow with stem

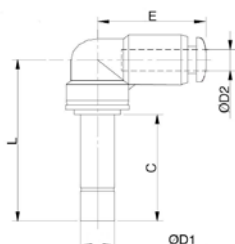

CODE	ØD1	ØD2	E	C	L	GR.
WTRLGJ0604	6	4	17,5	18,0	35,0	8,7
WTRLGJ0806	8	6	19,0	21,0	39,2	13,7
WTRLGJ1008	10	8	22,8	24,0	44,0	19,4
WTRLGJ1210	12	10	26,3	26,0	48,5	34,6



WTRLGJ-N

Reduced elbow with stem

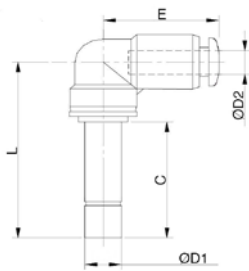

CODE	ØD1	ØD2	E	L	LB
WTRLGJ316-532	3/16	5/32	0,688	1,299	0,018
WTRLGJ1-4-532	1/4	5/32	0,688	1,377	0,019
WTRLGJ1-4-316	1/4	3/16	0,688	1,377	0,020
WTRLGJ516-1-4	5/16	1/4	0,748	1,543	0,030
WTRLGJ38-516	3/8	5/16	0,897	1,673	0,042
WTRLGJ1-2-38	1/2	3/8	1,035	2,078	0,076

WTRYJ

Union Y with stem

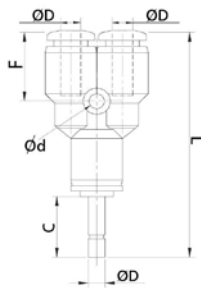

CODE	ØD	Ød	C	F	L	LB
WTRYJ0400	4	3,2	16,0	14,0	51,0	10,2
WTRYJ0600	6	3,2	18,0	14,8	54,3	14,4
WTRYJ0800	8	3,2	21,0	18,2	60,1	20,4
WTRYJ1000	10	4,2	24,0	19,5	71,6	38,1
WTRYJ1200	12	4,2	26,0	21,6	78,1	49,9

WTRYJ-N

Union Y with stem

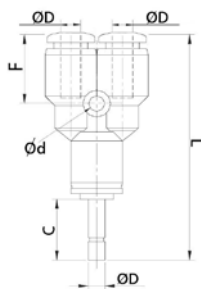

CODE	ØD	Ød	F	L	LB
WTRYJ532	5/32	0,125	0,551	2,007	0,022
WTRYJ316	3/16	0,125	0,562	2,019	0,030
WTRYJ1-4	1/4	0,125	0,582	2,137	0,031
WTRYJ516	5/16	0,125	0,716	2,366	0,044
WTRYJ38	3/8	0,165	0,767	2,818	0,083
WTRYJ1-2	1/2	0,165	0,850	3,074	0,11

WTRWJ

Reduced union Y with stem

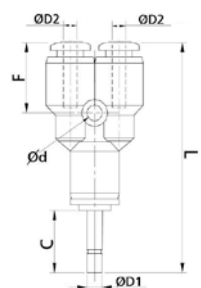

CODE	ØD1	ØD2	Ød	C	F	L	GR.
WTRWJ0604	6	4	3,2	18,0	14,0	53,0	14,5
WTRWJ0806	8	6	3,2	21,0	14,8	57,3	20,4
WTRWJ1008	10	8	4,2	24,0	18,2	64,1	35,5
WTRWJ1210	12	10	4,2	26,0	19,5	73,6	50,5



WTRWJ-N

Reduced union Y with stem

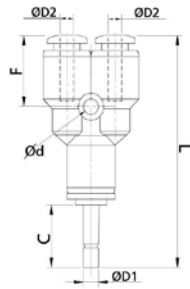

CODE	ØD1	ØD2	Ød	F	L	LB
WTRWJ1-4-532	1/4	5/32	0,125	0,551	2,086	0,031
WTRWJ516-1-4	5/16	1/4	0,125	0,582	2,255	0,044
WTRWJ38-516	3/8	5/16	0,165	0,716	2,523	0,078
WTRWJ1-2-38	1/2	3/8	0,165	0,767	2,897	0,111

WTRKJ

Multi-tee union with lateral stem

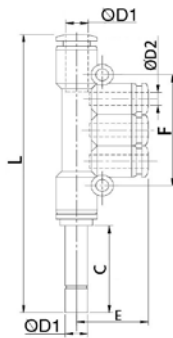

CODE	ØD1	ØD2	E	C	F	L	GR.
WTRKJ0604	6	4	19,0	18	36	74,8	4,2
WTRKJ0804	8	4	20,0	21	42	82,3	5,5
WTRKJ0806	8	6	20,3	21	42	82,3	7,3
WTRKJ1006	10	6	23,8	24	48	104,5	14,3
WTRKJ1008	10	8	24,3	24	48	104,5	18,2

WTRKJ-N

Multi-tee union with lateral stem

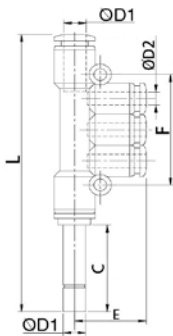

CODE	ØD1	ØD2	E	F	L	LB
WTRKJ316-532	3/16	5/32	0,748	1,417	2,866	0,008
WTRKJ1-4-532	1/4	5/32	0,748	1,417	2,944	0,009
WTRKJ516-532	5/16	5/32	0,787	1,653	3,240	0,012
WTRKJ516-1-4	5/16	1/4	0,799	1,653	3,240	0,016
WTRKJ38-1-4	3/8	1/4	0,937	1,889	4,114	0,031
WTRKJ38-516	3/8	5/16	0,956	1,889	4,115	0,040

WTRPF

Female plug

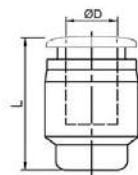

CODE	ØD	L	GR.
WTRPF04	4	17,5	2,6
WTRPF05	5	17,5	3,1
WTRPF06	6	17,5	3,7
WTRPF07	7	20,8	3,8
WTRPF08	8	20,8	4,2
WTRPF10	10	25,3	5,5
WTRPF12	12	25,6	9,3
WTRPF14	14	25,7	12,4
WTRPF15	15	27,0	15,3
WTRPF16	16	27,0	17,1



WTRIJ

Junction

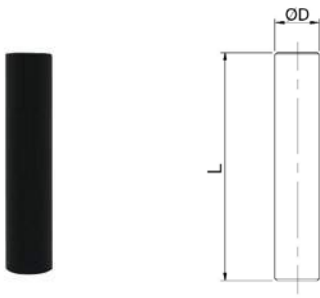

CODE	ØD	L	GR.
WTRIJ04	4	35	0,4
WTRIJ06	6	37	0,8
WTRIJ08	8	41	1,2
WTRIJ10	10	51	2,7
WTRIJ12	12	54	3,5
WTRIJ16	16	58	5,3

WTRIJ-N

Junction

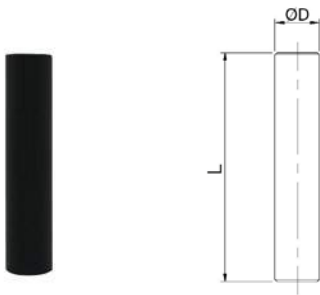

CODE	ØD	L	LB
WTRIJ532	5/32	1,377	0,008
WTRIJ316	3/16	1,377	0,016
WTRIJ1-4	1/4	1,456	0,001
WTRIJ516	5/16	1,614	0,002
WTRIJ38	3/8	2,007	0,005
WTRIJ1-2	1/2	2,125	0,007

WTRIG

Reduced junction

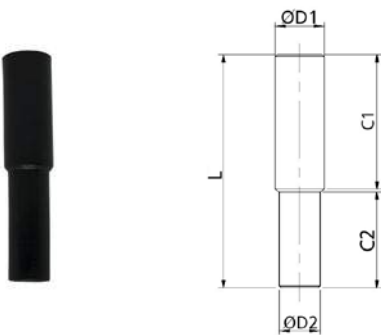

CODE	ØD1	ØD2	C1	C2	L	GR.
WTRIG0604	6	4	18	17	36	0,6
WTRIG0806	8	6	20	18	39	1,0
WTRIG1008	10	8	25	20	46	1,9
WTRIG1210	12	10	27	26	54	3,2
WTRIG1612	16	12	28	28	56	4,8

WTRIG-N

Reduced junction

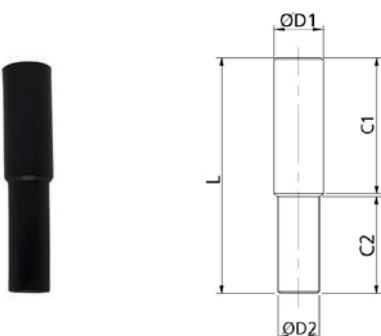

CODE	ØD1	ØD2	C1	C2	L	LB
WTRIG316-532	3/16	5/32	0,708	0,669	1,417	0,001
WTRIG1-4-532	1/4	5/32	0,708	0,669	1,417	0,001
WTRIG1-4-316	1/4	3/16	0,708	0,669	1,417	0,001
WTRIG516-1-4	5/16	1/4	0,787	0,708	1,535	0,002
WTRIG38-516	3/8	5/16	0,984	0,787	1,811	0,004
WTRIG1-2-38	1/2	3/8	1,062	1,023	2,125	0,007



WTRP

Male plug

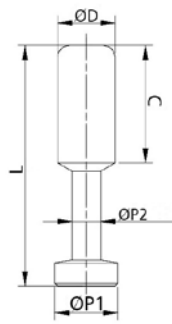

CODE	ØD	ØP1	ØP2	C	L	GR.
WTRP04	4	5,0	3,0	15,0	28	0,4
WTRP06	6	7,0	3,0	17,0	33	0,8
WTRP08	8	9,0	4,0	18,0	37	1,3
WTRP10	10	11,0	5,0	20,5	42	2,2
WTRP12	12	13,0	6,0	23,0	44	3,1

WTRP-N

Male plug

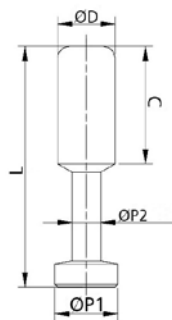

CODE	ØD	ØP1	ØP2	C	L	LB
WTRP532	5/32	0,196	0,118	0,590	1,102	0,008
WTRP316	3/16	0,196	0,118	0,590	1,102	0,0016
WTRP1-4	1/4	0,275	0,118	0,669	1,299	0,0017
WTRP516	5/16	0,354	0,157	0,708	1,456	0,0028
WTRP38	3/8	0,433	0,196	0,807	1,653	0,0048
WTRP1-2	1/2	0,511	0,236	0,905	1,732	0,0068

WTRUC-PRD

Union connector for DIN profile

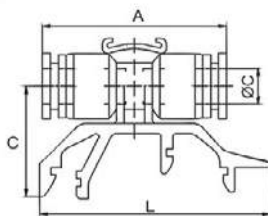

CODE	ØD	A	C	L	GR.
WTRUC-PRD04	4	34,6	22,0	45,0	8,0
WTRUC-PRD06	6	35,2	22,0	45,0	8,0
WTRUC-PRD08	8	39,1	22,7	45,0	10,0
WTRUC-PRD10	10	45,2	24,7	45,0	17,0

WTRCV

Applicable sleeve

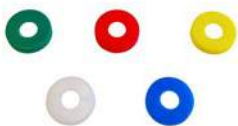

CODE	ØD						GR.
WTRCV04	4	WTRCV04BL	WTRCV04RO	WTRCV04BO	WTRCV04GL	WTRCV04VD	0,10
WTRCV06	6	WTRCV06BL	WTRCV06RO	WTRCV06BO	WTRCV06GL	WTRCV06VD	0,14

TR

Push-in fittings with barb connector

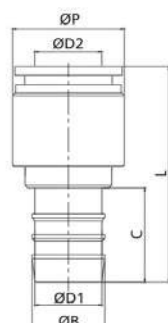

CODE	ØD	ØD1	ØP	C	L	GR.
TR1213P	12	1/2	20,0	10,8	40,8	24,0



FLOW REGULATORS

PLUS

WIDE SOLUTIONS ACCORDINGLY TO
EVERY KIND OF APPLICATION

LARGE RANGE OF MATERIALS
AVAILABLE

PRECISE REGULATION ABLE TO ENSURE
THE HIGHEST ENERGY SAVING

OPTIMIZED DIMENSIONS &
PERFORMANCES





p. 45 / **WTRFR-R**



p. 45 / **WTRFR-R-IN**



p. 46 / **WTRFR-G**



p. 46 / **WTRFR-G-IN**



p. 47 / **WTRFR-N**



p. 47 / **WTRFR-N-IN**



p. 48 / **WTRNSF**



p. 48 / **WTRNSF-N**







 -20°C ÷ 80°C

 Working pressure:
10 Bar

 Compressed air

 - Taper gas BSPT ISO 7
from R1/8" to R1/2" with teflon
- Parallel gas BSPP ISO 228
from G1/8" to G1/2"
- Metric ISO 262 M5
- NPT from N1/8" to N1/2"
- UNF 10-32

 Polyamide PA,
Polyurethane PU,
Polyethylene PE

Body: Nickel plated brass and high performance PBT

Collar: zinc

Sleeve: acetal resin POM

Seal: NBR sans silicone

Lock claw: stainless steel AISI 301

Handle: brass

O-ring: NBR silicon free

Lock nut: nickel plated brass

Back ring: POM



Products in compliance with the directive 1907/2006



RoHS2

Products in compliance with the directive 2011/65/UE

INSERTION OF THE TUBE INTO THE FITTING

- Make sure the tube is fully inserted into the fitting.
- To insert the tube into the fitting cut the tube off square (90°), insert tube up to the fitting end stop, and pull back gently to make sure it is correctly connected.
- If there is any damage or scratches on the tube surface the tube is an oval shape, air leakage and tube release may occur. Check the tube condition carefully.
- The OD of polyurethane tube expands when pressure is applied. Reinsertion into the fitting may not always be possible. Check the OD of the tube and renew it the expansion is out of tolerance.

DISCONNECTION OF THE TUBE FROM THE FITTING

- Make sure the pressure in the system is zero before releasing the tube from the fitting.
- To release the tube, press the release sleeve towards the fitting with one hand and pull the tube away from the fitting with the other hand.
- Always remove the section of tube previously inserted into the fitting before reinserting the tube by cutting back the tube. Always use the correct tube cutter in order to cut the tube square and free of damage.

TOLERANCE - TUBE

Ø TUBE (mm)	4	6	8	10	12
TOLERANCE (mm)	± 0,1	± 0,1	± 0,1	± 0,15	± 0,15

Ø TUBE (inch)	5/32	1/4	5/16	3/8	1/2
TOLERANCE (inch)	± 0,003"	± 0,003"	± 0,003"	± 0,005"	± 0,005"

CONSTRUCTION DETAILS

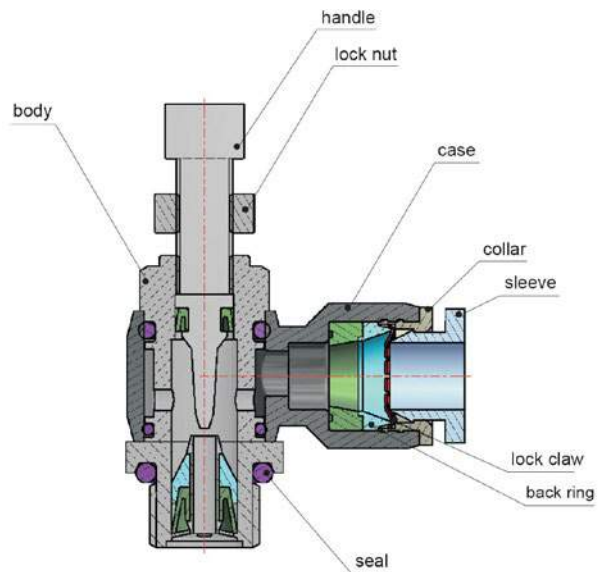

"exhaust" version - OUT

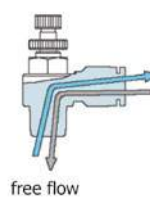

free flow

"supply" version - IN

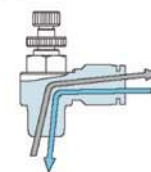

regulated flow

regulated flow

free flow



WTRFR-R

Banjo male elbow BSPT thread unidirectional nickel plated with handle regulation

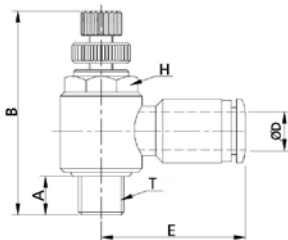

CODE	ØD	T	A	B	E	H	GR.
WTRFR04R01	4	R 1/8"	7,0	39,7	22,3	10	18,0
WTRFR04R02		R 1/4"	9,5	46,4	24,1	14	35,9
WTRFR06R01	6	R 1/8"	7,0	39,7	23,1	10	18,5
WTRFR06R02		R 1/4"	9,5	46,4	25,1	14	36,5
WTRFR06R03		R 3/8"	10,5	53,4	26,8	19	60,5
WTRFR06R04	6	R 1/2"	13,5	57,9	29,8	24	92,7
WTRFR08R01	8	R 1/8"	7,0	39,7	25,6	10	19,3
WTRFR08R02		R 1/4"	9,5	46,4	28,6	14	37,3
WTRFR08R03		R 3/8"	10,5	53,4	29,6	19	61,1
WTRFR08R04		R 1/2"	13,5	57,9	32,6	24	93,4
WTRFR10R01	10	R 1/8"	7,0	39,7	28,8	10	22,7
WTRFR10R02		R 1/4"	9,5	46,4	31,0	14	40,7
WTRFR10R03		R 3/8"	10,5	53,4	31,6	19	64,5
WTRFR10R04		R 1/2"	13,5	57,9	34,6	24	96,8
WTRFR12R02	12	R 1/4"	9,5	46,4	33,5	14	42,2
WTRFR12R03		R 3/8"	10,5	53,4	35,6	19	66,1
WTRFR12R04		R 1/2"	13,5	57,9	36,6	24	98,3

WTRFR-R-IN

Banjo male elbow BSPT thread unidirectional nickel plated with handle regulation

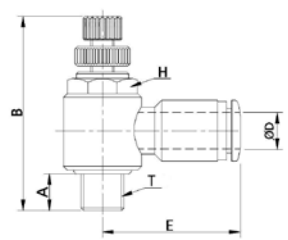

CODE	ØD	T	A	B	E	H	GR.
WTRFR04R01-IN	4	R 1/8"	7,0	39,7	22,3	10	18,0
WTRFR04R02-IN		R 1/4"	9,5	46,4	24,1	14	35,9
WTRFR06R01-IN	6	R 1/8"	7,0	39,7	23,1	10	18,5
WTRFR06R02-IN		R 1/4"	9,5	46,4	25,1	14	36,5
WTRFR06R03-IN		R 3/8"	10,5	53,4	26,8	19	60,5
WTRFR06R04-IN	6	R 1/2"	13,5	57,9	29,8	24	92,7
WTRFR08R01-IN	8	R 1/8"	7,0	39,7	25,6	10	19,3
WTRFR08R02-IN		R 1/4"	9,5	46,4	28,6	14	37,3
WTRFR08R03-IN		R 3/8"	10,5	53,4	29,6	19	61,1
WTRFR08R04-IN		R 1/2"	13,5	57,9	32,6	24	93,4
WTRFR10R01-IN	10	R 1/8"	7,0	39,7	28,8	10	22,7
WTRFR10R02-IN		R 1/4"	9,5	46,4	31,0	14	40,7
WTRFR10R03-IN		R 3/8"	10,5	53,4	31,6	19	64,5
WTRFR10R04-IN		R 1/2"	13,5	57,9	34,6	24	96,8
WTRFR12R02-IN	12	R 1/4"	9,5	46,4	33,5	14	42,2
WTRFR12R03-IN		R 3/8"	10,5	53,4	35,6	19	66,1
WTRFR12R04-IN		R 1/2"	13,5	57,9	36,6	24	98,3



WTRFR-G

Banjo male elbow BSPP & metric thread unidirectional nickel plated with handle regulation

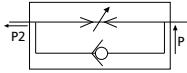
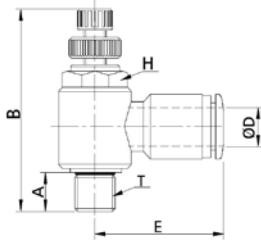

CODE	ØD	T	A	B	E	H	GR.
WTRFR04M5	4	M5x0,8	4,0	29,3	20,0	8	-
WTRFR04G01		G 1/8"	5,8	39,7	22,3	10	18,0
WTRFR04G02		G 1/4"	7,3	46,4	24,1	14	35,9
WTRFR06M5	6	M5x0,8	4,0	29,3	21,9	8	-
WTRFR06G01		G 1/8"	5,8	39,7	23,1	10	18,5
WTRFR06G02		G 1/4"	7,3	46,4	25,1	14	36,5
WTRFR06G03		G 3/8"	8,5	53,4	26,8	19	60,5
WTRFR06G04		G 1/2"	10,0	57,9	29,8	24	92,7
WTRFR08G01	8	G 1/8"	5,8	39,7	25,6	10	19,3
WTRFR08G02		G 1/4"	7,3	46,4	28,6	14	37,3
WTRFR08G03		G 3/8"	8,5	53,4	29,6	19	61,1
WTRFR08G04		G 1/2"	10,0	57,9	32,6	24	93,4
WTRFR10G01	10	G 1/8"	5,8	39,7	28,8	10	22,7
WTRFR10G02		G 1/4"	7,3	46,4	31,1	14	40,7
WTRFR10G03		G 3/8"	8,5	53,4	31,6	19	64,5
WTRFR10G04		G 1/2"	10,0	57,9	34,6	24	96,8
WTRFR12G02	12	G 1/4"	7,3	46,4	33,5	14	42,2
WTRFR12G03		G 3/8"	8,5	53,4	35,6	19	66,1
WTRFR12G04		G 1/2"	10,0	57,9	36,6	24	98,3

WTRFR-G-IN

Banjo male elbow BSPP & metric thread unidirectional nickel plated with handle regulation

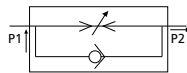
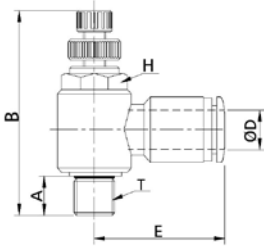

CODE	ØD	T	A	B	E	H	GR.
WTRFR04M5-IN	4	M5x0,8	4,0	29,3	20,0	8	-
WTRFR04G01-IN		G 1/8"	5,8	39,7	22,3	10	18,0
WTRFR04G02-IN		G 1/4"	7,3	46,4	24,1	14	35,9
WTRFR06M5-IN	6	M5x0,8	4,0	29,3	21,9	8	-
WTRFR06G01-IN		G 1/8"	5,8	39,7	23,1	10	18,5
WTRFR06G02-IN		G 1/4"	7,3	46,4	25,1	14	36,5
WTRFR06G03-IN		G 3/8"	8,5	53,4	26,8	19	60,5
WTRFR06G04-IN		G 1/2"	10,0	57,9	29,8	24	92,7
WTRFR08G01-IN	8	G 1/8"	5,8	39,7	25,6	10	19,3
WTRFR08G02-IN		G 1/4"	7,3	46,4	28,6	14	37,3
WTRFR08G03-IN		G 3/8"	8,5	53,4	29,6	19	61,1
WTRFR08G04-IN		G 1/2"	10,0	57,9	32,6	24	93,4
WTRFR10G01-IN	10	G 1/8"	5,8	39,7	28,8	10	22,7
WTRFR10G02-IN		G 1/4"	7,3	46,4	31,1	14	40,7
WTRFR10G03-IN		G 3/8"	8,5	53,4	31,6	19	64,5
WTRFR10G04-IN		G 1/2"	10,0	57,9	34,6	24	96,8
WTRFR12G02-IN	12	G 1/4"	7,3	46,4	33,5	14	42,2
WTRFR12G03-IN		G 3/8"	8,5	53,4	35,6	19	66,1
WTRFR12G04-IN		G 1/2"	10,0	57,9	36,6	24	98,3



WTRFR-N

Banjo male elbow NPT & UNF thread unidirectional nickel plated with handle regulation

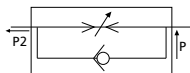
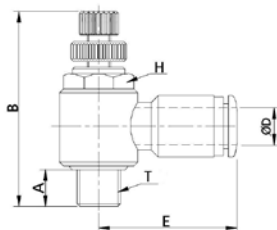

CODE	ØD	T	A	B	E	H	GR.
WTRFR532UF1032	5/32	UNF 10-32	0,149	1,153	0,787	0,314	0,037
WTRFR532N01	5/32	N 1/8"	0,295	1,578	0,889	0,437	0,039
WTRFR1-4UF1032	1/4	UNF 10-32	0,149	1,153	0,866	0,314	0,038
WTRFR1-4N01	1/4	N 1/8"	0,295	1,578	0,909	0,437	0,040
WTRFR1-4N02	1/4	N 1/4"	0,413	1,858	0,988	0,562	0,080
WTRFR1-4N03	1/4	N 3/8"	0,433	2,122	1,055	0,748	0,133
WTRFR516N01	5/16	N 1/8"	0,295	1,578	1,007	0,437	0,042
WTRFR516N02	5/16	N 1/4"	0,413	1,858	1,125	0,562	0,082
WTRFR516N03	5/16	N 3/8"	0,433	2,122	1,165	0,748	0,134
WTRFR38N02	3/8	N 1/4"	0,413	1,858	1,220	0,562	0,089
WTRFR38N03	3/8	N 3/8"	0,433	2,122	1,244	0,748	0,142
WTRFR38N04	3/8	N 1/2"	0,551	2,299	1,362	1	0,213
WTRFR1-2N02	1/2	N 3/8"	0,433	2,122	1,401	0,748	0,093
WTRFR1-2N03	1/2	N 1/2"	0,551	2,299	1,440	1	0,145

WTRFR-N-IN

Banjo male elbow NPT & UNF thread unidirectional nickel plated with handle regulation

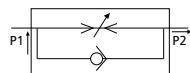
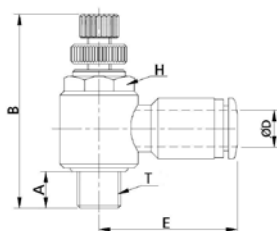

CODE	ØD	T	A	B	E	H	GR.
WTRFR532UF1032-IN	5/32	UNF 10-32	0,149	1,153	0,787	0,314	0,037
WTRFR532N01-IN		N 1/8"	0,295	1,578	0,889	0,437	0,039
WTRFR1-4UF1032-IN	1/4	UNF 10-32	0,149	1,153	0,866	0,314	0,038
WTRFR1-4N01-IN		N 1/8"	0,295	1,578	0,909	0,437	0,040
WTRFR1-4N02-IN		N 1/4"	0,413	1,858	0,988	0,562	0,080
WTRFR1-4N03-IN		N 3/8"	0,433	2,122	1,055	0,748	0,133
WTRFR516N01-IN	5/16	N 1/8"	0,295	1,578	1,007	0,437	0,042
WTRFR516N02-IN		N 1/4"	0,413	1,858	1,125	0,562	0,082
WTRFR516N03-IN		N 3/8"	0,433	2,122	1,165	0,748	0,134
WTRFR38N02-IN	3/8	N 1/4"	0,413	1,858	1,220	0,562	0,089
WTRFR38N03-IN		N 3/8"	0,433	2,122	1,244	0,748	0,142
WTRFR38N04-IN		N 1/2"	0,551	2,299	1,362	1	0,213
WTRFR1-2N02-IN	1/2	N 3/8"	0,433	2,122	1,401	0,748	0,093
WTRFR1-2N03-IN		N 1/2"	0,551	2,299	1,440	1	0,145



WTRNSF

Flat flow regulators metric sizes unidirectional nickel plated with handle regulation

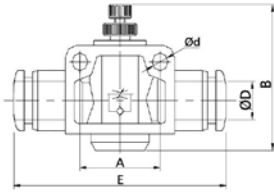

CODE	ØD	Ød	A	B	E	GR.
WTRNSF04	4	3,2	14,0	28,8	39,5	11,7
WTRNSF06	6	4,3	20,0	42,6	47,6	27,0
WTRNSF08	8	4,3	22,0	44,3	52,6	39,5
WTRNSF10	10	4,3	26,0	53,4	60,5	69,0
WTRNSF12	12	4,3	32,0	55,6	74,2	113,2

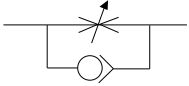

WTRNSF-N

Flat flow regulators imperial sizes unidirectional nickel plated with handle regulation

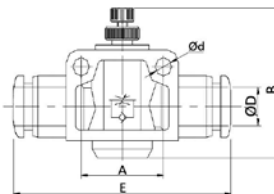

CODE	ØD	Ød	A	B	E	GR.
WTRNSF532	5/32	0,125	0,551	1,133	1,555	0,025
WTRNSF316	3/16	0,125	0,551	1,133	1,578	0,056
WTRNSF1-4	1/4	0,169	0,787	1,677	1,874	0,059
WTRNSF516	5/16	0,169	0,866	1,744	2,070	0,087
WTRNSF38	3/8	0,169	1,023	2,102	2,381	0,152
WTRNSF1-2	1/2	0,169	1,259	2,188	2,921	0,249

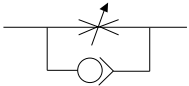

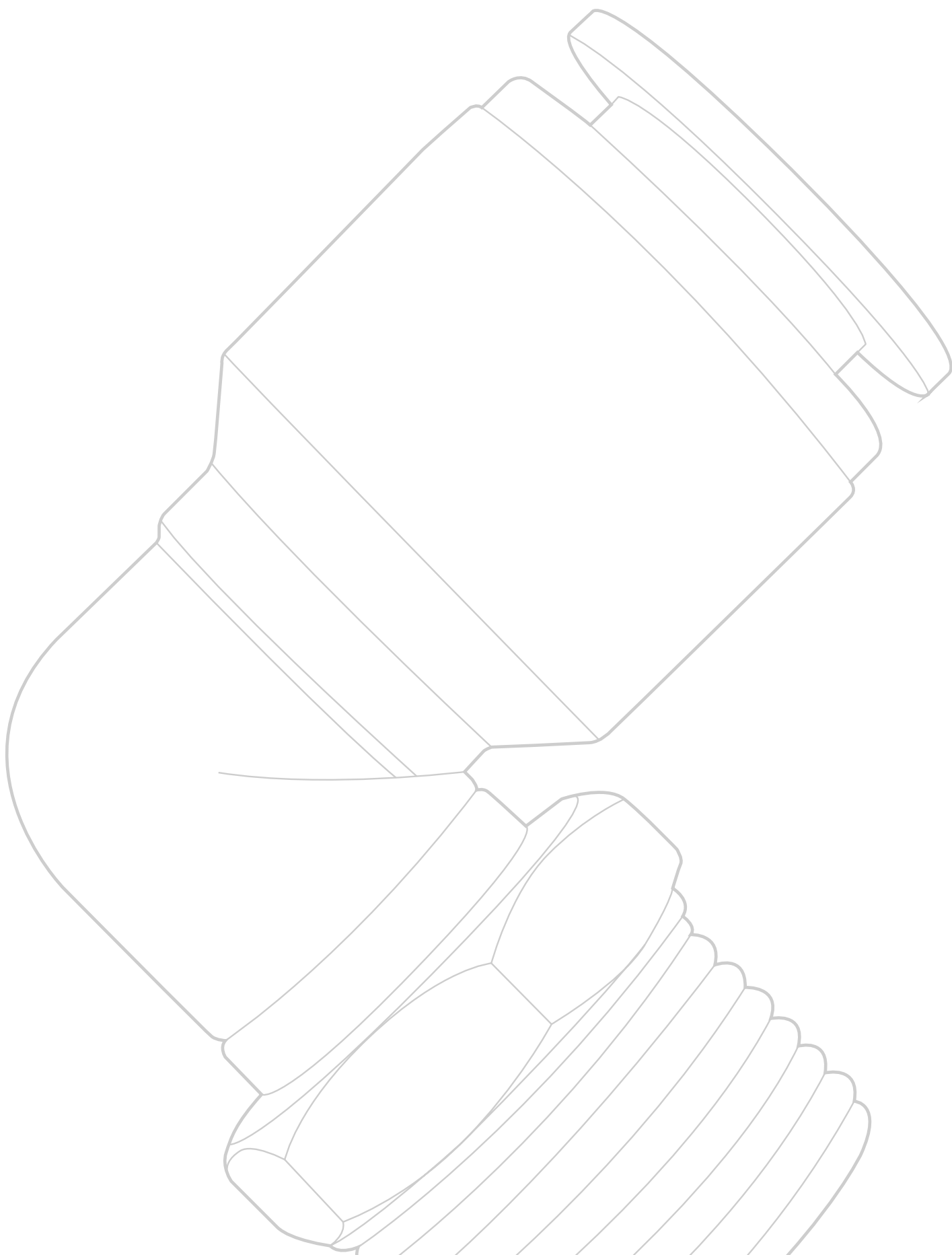

POLYURETHANE TUBE ON POLYESTER BASIS

PLUS

**EXCEPTIONAL FLEXIBILITY ALLOWS
TIGHTER BEND RADIUS**

IDEAL FOR ROBOTICS APPLICATIONS

**DURABLE, LIGHT WEIGHT, ABRASION
RESISTANT, CHEMICAL RESISTANT AND
COST-EFFECTIVE**

**IDEAL FOR PNEUMATIC CONNECTIONS
IN LOW AMBIENT TEMPERATURE
CONDITIONS**

**SELF-RETRACTING AND SELF-STORING
COIL TUBE WITH EXCELLENT MEMORY
CHARACTERISTICS**

**AVAILABLE IN 8 COLORS AND EASILY
MANAGEABLE THANKS TO THE PLASTIC
COIL**

**SILICON FREE SUITABLE FOR THE
PAINTING AND AUTOMOTIVE SECTORS**

**SUITABLE FOR USE WITH VACUUM DUE
TO THE PARTICULARLY HARD SURFACE**





p. 53 / **PUES**



p. 53 / **PUES-BX**





0°C ÷ +60°C



Working pressure:

See the table

Burst pressure:

See the table

Negative pressure:

- 750 mmHg (- 0,999 Bar)



Compressed air & vacuum.

Do not use for water applications.

TOLERANCE

da Ø3 a Ø8: ± 0,1

da Ø10 a Ø16: ± 0,15

HARDNESS

Shore 98 A



Polyurethane on polyester basis

FEATURES

Polyurethane tube on polyester basis has a high flexibility at low temperatures and a good tolerance to wear and tear & chemicals.



REACH

Products in compliance with the directive 1907/2006



RoHS2

Products in compliance with the directive 2011/65/EU

SILICON FREE

DATASHEET

Polyurethane tube on polyester basis

CODE	Ø ODxID	MINIMUM BENDING RADIUS (mm)	WORKING PRESSURE 23 °C (Bar)	BURST PRESSURE 23 °C (Bar)	MEASURE G/MT	Q.TY FOR ROLL (mt)
PUES0302	3X2	8	10,0	30,0	7,5	100
PUES0402	4X2	12	10,0	30,0	10,0	100
PUES0425	4X2,5	12	10,0	30,0	9,0	100
PUES0604	6X4	15	8,5	25,5	18,0	100
PUES0805	8X5	20	8,5	25,5	35,0	100
PUES0855	8X5,5	20	8,5	25,5	38,0	100
PUES1065	10X6,5	25	8,5	25,5	55,0	100
PUES1007	10X7	25	8,0	24,0	49,0	100
PUES1208	12X8	35	8,5	25,5	78,0	100
PUES1209	12X9	35	7,0	21,0	61,0	100
PUES1410	14X10	45	8,0	18,0	108,0	50
PUES1611	16X11	50	8,0	18,0	132,0	50
PUES1612	16X12	60	7,0	16,0	122,0	50



PUES











Polyurethane tube on polyester basis in roll

Sizes ODxID	 Light blue	 Black	 Red	 Yellow	 Green	 Grey	 Transparent	 Transparent light blue
3X2	PUES0302AZ							
4X2	PUES0402AZ							
4X2,5	PUES0425AZ	PUES0425NE	PUES0425RO	PUES0425GL	PUES0425VD	PUES0425SL	PUES0425TR	PUES0425AZTR
6X4	PUES0604AZ	PUES0604NE	PUES0604RO	PUES0604GL	PUES0604VD	PUES0604SL	PUES0604TR	PUES0604AZTR
8X5	PUES0805AZ			PUES0805GL				
8X5,5	PUES0855AZ	PUES0855NE	PUES0855RO	PUES0855GL	PUES0855VD	PUES0855SL	PUES0855TR	PUES0855AZTR
10X6,5	PUES1065AZ			PUES1065GL				
10X7	PUES1007AZ	PUES1007NE	PUES1007RO	PUES1007GL	PUES1007VD		PUES1007TR	PUES1007AZTR
12X8	PUES1208AZ	PUES1208NE		PUES1208GL				
12X9	PUES1209AZ	PUES1209NE	PUES1209RO	PUES1209GL	PUES1209VD	PUES1209SL	PUES1209TR	PUES1209AZTR
14X10	PUES1410AZ							
16X11	PUES1611AZ							
16X12	PUES1612AZ							

PUES-BX



Polyurethane tube on polyester basis in box

Sizes ODxID	 Light blue	 Black	 Red	 Yellow	 Green	 Grey	 Transparent	 Transparent light blue
3X2	PUES0302AZ-25BX							
4X2	PUES0402AZ-25BX							
4X2,5	PUES0425AZ-25BX	PUES0425NE-25BX	PUES0425RO-25BX	PUES0425GL-25BX	PUES0425VD-25BX	PUES0425SL-25BX	PUES0425TR-25BX	PUES0425AZTR-25BX
6X4	PUES0604AZ-25BX	PUES0604NE-25BX	PUES0604RO-25BX	PUES0604GL-25BX	PUES0604VD-25BX	PUES0604SL-25BX	PUES0604TR-25BX	PUES0604AZTR-25BX
8X5	PUES0805AZ-25BX			PUES0805GL-25BX				
8X5,5	PUES0855AZ-25BX	PUES0855NE-25BX	PUES0855RO-25BX	PUES0855GL-25BX	PUES0855VD-25BX	PUES0855SL-25BX	PUES0855TR-25BX	PUES0855AZTR-25BX
10X6,5	PUES1065AZ-25BX			PUES1065GL-25BX				
10X7	PUES1007AZ-25BX	PUES1007NE-25BX	PUES1007RO-25BX	PUES1007GL-25BX	PUES1007VD-25BX		PUES1007TR-25BX	PUES1007AZTR-25BX
12X8	PUES1208AZ-25BX	PUES1208NE-25BX		PUES1208GL-25BX				
12X9	PUES1209AZ-25BX	PUES1209NE-25BX	PUES1209RO-25BX	PUES1209GL-25BX	PUES1209VD-25BX	PUES1209SL-25BX	PUES1209TR-25BX	PUES1209AZTR-25BX
14X10	PUES1410AZ-25BX							
16X11	PUES1611AZ-25BX							
16X12	PUES1612AZ-25BX							





Tierre Group S.p.a.

via dell'Industria, 18 - 20032 Cormano (MI)

Tel. +39 02 663088.1 - Fax +39 02 66304172

www.tierregroup.com - info@tierregroup.com

C.F. e P.IVA 12437570158

Cap. Soc. Euro 120.000,00 i.v. - REA MI-1558390